

Federal Reserve Bank of New York
Staff Reports

Shadow Banking

Zoltan Pozsar
Tobias Adrian
Adam Ashcraft
Hayley Boesky

Staff Report no. 458
July 2010

This paper presents preliminary findings and is being distributed to economists and other interested readers solely to stimulate discussion and elicit comments. The views expressed in this paper are those of the authors and are not necessarily reflective of views at the Federal Reserve Bank of New York or the Federal Reserve System. Any errors or omissions are the responsibility of the authors.

Shadow Banking

Zoltan Pozsar, Tobias Adrian, Adam Ashcraft, and Hayley Boesky

Federal Reserve Bank of New York Staff Reports, no. 458

July 2010

JEL classification: G20, G28, G01

Abstract

The rapid growth of the market-based financial system since the mid-1980s changed the nature of financial intermediation in the United States profoundly. Within the market-based financial system, “shadow banks” are particularly important institutions. Shadow banks are financial intermediaries that conduct maturity, credit, and liquidity transformation without access to central bank liquidity or public sector credit guarantees. Examples of shadow banks include finance companies, asset-backed commercial paper (ABCP) conduits, limited-purpose finance companies, structured investment vehicles, credit hedge funds, money market mutual funds, securities lenders, and government-sponsored enterprises.

Shadow banks are interconnected along a vertically integrated, long intermediation chain, which intermediates credit through a wide range of securitization and secured funding techniques such as ABCP, asset-backed securities, collateralized debt obligations, and repo. This intermediation chain binds shadow banks into a network, which is the shadow banking system. The shadow banking system rivals the traditional banking system in the intermediation of credit to households and businesses. Over the past decade, the shadow banking system provided sources of inexpensive funding for credit by converting opaque, risky, long-term assets into money-like and seemingly riskless short-term liabilities. Maturity and credit transformation in the shadow banking system thus contributed significantly to asset bubbles in residential and commercial real estate markets prior to the financial crisis.

We document that the shadow banking system became severely strained during the financial crisis because, like traditional banks, shadow banks conduct credit, maturity, and liquidity transformation, but unlike traditional financial intermediaries, they lack access to public sources of liquidity, such as the Federal Reserve’s discount window, or public sources of insurance, such as federal deposit insurance. The liquidity facilities of the Federal Reserve and other government agencies’ guarantee schemes were a direct response to the liquidity and capital shortfalls of shadow banks and, effectively, provided either a backstop to credit intermediation by the shadow banking system or to traditional banks for the exposure to shadow banks. Our paper documents the institutional features of shadow banks, discusses their economic roles, and analyzes their relation to the traditional banking system.

Key words: shadow banking, financial intermediation

Pozsar, Adrian, Ashcraft: Federal Reserve Bank of New York; Boesky, currently with Bank of America Merrill Lynch, was with the Federal Reserve Bank of New York when this paper was written. Corresponding author: Zoltan Pozsar (zoltan.pozsar@ny.frb.org; phone: +1-917-602-0196). The views expressed in this paper are those of the authors and do not necessarily reflect the position of the Federal Reserve Bank of New York or the Federal Reserve System.

AUTHORS' NOTE

Our monograph “Shadow Banking” documents the origins, evolution and economic role of the shadow banking system. Its aim is to aid regulators and policymakers globally to reform, regulate and supervise the process of securitized credit intermediation in a market-based financial system.

The monograph has four sections. Section one, spanning the first 70 pages is intended as a standalone paper, an “executive summary” of the monograph. We consider this section complete. Sections two to four discuss the institutional details of every type of shadow bank in the shadow banking system: their activities, funding strategies, size and the credit and liquidity backstops that were extended to them during the financial crisis. These sections, spanning pages 70 to 230 remain a work in progress and are unpublished. The full monograph’s table of contents is provided below.

While the financial crisis of 2007-2009 re-shaped the financial system considerably, most components of the shadow banking system are still functioning today, albeit in a much impaired fashion. As such, we describe the shadow banking system in present tense. We recommend printing the accompanying map of the shadow banking system as a 36” by 48” poster.

Introduction

Part I—Shadow Banking

I.1 What Is Shadow Credit Intermediation?

I.2 The Shadow Credit Intermediation Process

I.3 The Instruments of Shadow Credit Intermediation

I.4 The Shadow Banking System

I.4.1 The Government-Sponsored Shadow Banking Sub-System

I.4.2 The "Internal" Shadow Banking Sub-System

I.4.2.1 The Credit Intermediation Process of Financial Holding Companies (FHCs)

I.4.2.2 The Shadow Banking Activities of European Banks

I.4.3 The "External" Shadow Banking Sub-System

I.4.3.1 The Credit Intermediation Process of Diversified Broker-Dealers (DBDs)

I.4.3.2 The Credit Intermediation Process of Independent Specialists

I.4.3.3 The Credit Insurance Services of Private Credit Risk Repositories

I.4.4 The "Parallel" Banking System

I.5 Funding the Shadow Banking System

I.5.1 The Borrowers of Wholesale Funds

I.5.2 The Providers of Wholesale Funding

I.5.3 The Continuum of Cash Management Strategies

I.6 Backstopping the Shadow Banking System

I.7 Conclusions

Part II—The Shadow Credit Intermediation Process - **UNPUBLISHED**

II.1 Step (1)—Loan Origination

II.1.1 Finance Companies

II.1.1.1 Standalone Finance Companies

II.1.1.2 Captive Finance Companies

II.1.1.3 FHC and DBD-Affiliated Finance Companies

II.1.2 Loan-Level Credit Risk Repositories

II.1.2.1 Public Loan-Level Credit Risk Repositories

The FHA's Credit Puts on Non-Conforming Mortgages

The DoE's Credit Puts on FFELP Student Loans

The SBA's Credit Puts on Small Business Loans

II.1.2.2 Private Loan-Level Credit Risk Repositories

Mortgage Insurers' Credit Puts on Non-Conforming Mortgages

Monoline Insurers' Credit Puts on State and Municipal Bonds

II.2 Step (2)—Loan Warehousing

II.2.1 Officially-Enhanced Loan Warehousing/Funding

- II.2.1.1 Federal Deposit Insurance (FDIC)*
- II.2.1.2 Federal Home Loan Bank Advances*
- II.2.1.3 Industrial Loan Companies (ILCs)*
- II.2.1.3 Federal Savings Banks (FSBs)*

II.2.2 Privately-Enhanced Loan Warehousing/Funding

- II.2.2.1 Single-Seller Conduits*
- II.2.2.2 Multi-Seller Conduits*
- II.2.2.3 Independent Conduits*
- II.2.2.4 Straight-A Funding, LLC*

II.3 Step (3)—Issuance of ABS

II.3.1 Comparing ABCP and Term ABS

II.3.2 The Role of Broker-Dealers

- II.3.1.1 "Internal" Broker-Dealer Clients*
- II.3.1.2 "External" Broker-Dealer Clients*

II.3.3 The Types of Term ABS

II.3.4 Security-Level Credit Risk Repositories

II.3.4.1 Public Security-Level Credit Risk Repositories

The GSEs' Credit Puts on Agency MBS

II.3.4.2 Private Security-Level Credit Risk Repositories

Monoline Insurers' Credit Puts on ABS and ABS CDOs

Diversified Insurance Companies' Credit Puts on ABS CDOs

Credit Derivative Product Companies' Credit Puts on Bonds

Credit Hedge Funds' Credit Puts on Bonds

II.4 Step (4)—ABS Warehousing

II.4.1 Broker-Dealer Trading Books

II.4.2 Hybrid and TRS/Repo Conduits

II.5 Step (5)—Issuance of ABS CDOs

II.5.1 The Evolution of CDOs: Balance Sheet CDOs → Arbitrage CDOs → ABS CDOs

II.5.2 A Post Mortem of ABS CDOs

II.6 Step (6)—ABS Intermediation

II.6.1 The Rationale for Maturity Transformation

II.6.2 The Role of ABS Intermediaries

II.6.3 Public ABS Intermediaries

II.6.3.1 The GSEs' Retained Portfolios

II.6.4 Private ABS Intermediaries

- II.6.4.1 Limited Purpose Finance Companies (LPFCs)*
- II.6.4.2 Structured Investment Vehicles (SIVs)*
- II.6.4.3 Securities Arbitrage Conduits*
- II.6.4.4 Credit Hedge Funds*

II.6.5 ABS Intermediation

II.7 Step (7)—Wholesale Funding

II.7.1 The Tri-Party Repo System

II.7.2 The Providers of Short-Term Wholesale Funding

II.7.2.1 *Regulated Money Market Intermediaries*

2(a)-7 Money Market Mutual Funds (MMMFs)

2(a)-7 Treasury Only and Government Only MMMFs

2(a)-7 Repo and Prime MMMFs

II.7.2.2 *Unregulated Money Market Intermediaries*

Overnight Sweep Agreements

3(c)-7 Cash "Plus", Enhanced Cash and Ultra-Short Bond Funds

II.7.2.3 *Direct Money Market Investors*

Bank, Corporate and Other Institutional Treasurers

State and Local Government Treasurers (LGIPs)

Securities Lenders' Cash Collateral Reinvestment Accounts

High Net Worth and Ultra High Net Worth Individuals

II.7.3 The Providers of Medium- to Long-Term Wholesale Funding

II.7.3.1 *Fixed Income Mutual Funds*

II.7.3.2 *Pension Funds*

II.7.3.3 *Insurance Companies*

Part III—Measuring the Size of the Shadow Banking System - **UNPUBLISHED**

III.1 The "AuM" Approach

III.2 The Issued Liabilities Approach

III.3 What Share of the U.S. Current Account Deficit Did the Shadow Banking System Fund?

Part IV—Backstopping the Shadow Banking System - **UNPUBLISHED**

IV.1 Modern Financial Crises

IV.2 The Liquidity Backstops of the Shadow Banking System

IV.3 The Liability Guarantees of the Shadow Banking System

IV.4 The Timeline of Responses

IV.5 Those Who Were Not Backstopped: Was It a Mistake Not To?

Appendix of Tables - **UNPUBLISHED**

References

PART I—SHADOW BANKING

The financial crisis of 2007-2009 is not unprecedented in the context of the banking crises of the free banking era. Over 100 years ago, the traditional banking system was an inherently fragile, shadow banking system operating without credible public-sector backstops and limited regulation.² While there is some evidence that the creation of the Federal Reserve System as lender of last resort in 1913 led to a reduction in the occurrence of bank runs, it did not completely eliminate them (see Friedman and Schwartz (1971)). It was only after four years of Depression that in 1933 federal deposit insurance was introduced through the Federal Deposit Insurance Corporation (FDIC), which ultimately transformed banking into a stable activity insulated from deposit runs.

Credit intermediation involves maturity, credit, and liquidity transformation which can significantly reduce the cost of credit relative to direct lending. However, the reliance on short-term liabilities by banks to fund illiquid long-term assets is an inherently fragile activity that is prone to runs. As the failure of banks can have large, adverse effects on the real economy (see Bernanke (1987) and Ashcraft (2005)), governments chose to shield them from the risks inherent in reliance on short-term funding by granting them access to liquidity and credit put options in the form of discount window access and deposit insurance, respectively. The presence of these put options, combined with the difficulty of accurately pricing them, creates well-known incentives for excessive leverage and risk-taking, and motivates the need for prudential regulation and risk limits.

² Our usage of the term “traditional bank” refers to all forms of depository institutions, including commercial banks, thrifts, credit unions, industrial loan companies and federal savings banks. Unless the text demands more precision, we refer to traditional banks simply as “banks” throughout the paper. The category of commercial banks also includes large, money center banks. Investment banks, which we refer to as broker-dealers, are not included in the category of traditional banks. Other, specialist banks, such as tri-party clearing banks and custodian banks, are not depository institutions, but belong to bank holding companies with commercial bank subsidiaries. We refer to clearing and custodian banks as such, and not simply as “banks”.

Like the traditional banking system of the 1900s, the shadow banking system of the 2000s engaged in significant amounts of maturity, credit, and liquidity transformation, which made it just as fragile. In a further parallel, the run on the shadow banking system, which began in the summer of 2007 and peaked following the failure of Lehman, was only stabilized after the creation of a series of official liquidity facilities and credit guarantees: the Federal Reserve's emergency liquidity facilities amounted to functional backstops of the steps involved in the credit intermediation process that runs through the shadow banking system, and the liabilities and mechanisms through which it is funded. Meanwhile, the FDIC's Temporary Liquidity Guarantee Program (TLGP) of financial institutions' senior unsecured debt and corporate transaction accounts, and the U.S. Treasury's temporary guarantee program of money market funds, are modern-day equivalents of deposit insurance.³

While today's traditional banking system was made safe and stable through the deposit insurance and liquidity provision provided by the public sector, the shadow banking system—prior to the onset of the financial crisis of 2007-2009—was presumed to be safe due to liquidity and credit puts provided by the private sector. These puts underpinned the perceived risk-free, highly liquid nature of most AAA-rated assets that collateralized credit repos and shadow banks' liabilities more broadly.

However, once private sector put providers' solvency was questioned, even if solvency in some cases was perfectly satisfactory, confidence in the liquidity and credit puts that underpinned the stability of the shadow banking system vanished, triggering a run. Ultimately, a wholesale substitution of private liquidity and credit puts with official liquidity and credit puts became necessary to stop the run, but not before large portions of the shadow banking system were already gone.

³ We exclude discussions of capital injections and supervisory actions such as the SCAP from the current version of our monograph.

The obvious danger in using private sector balance sheets to underwrite large quantities of credit and liquidity puts against high-quality structured credit assets is the difficulty in accurately measuring correlation. In particular, AAA-rated tranches are generally structured to withstand idiosyncratic risk, but by their nature are vulnerable to systematic risk and particularly tail risk (see Coval, Jurek and Stafford (2009)). Consequently, the performance of highly-rated structured securities exhibits higher correlation in an extreme environment than one would predict from observed behavior in a more benign environment. Moreover, in a major liquidity crisis of the type experienced in 2007-2009, all securities become highly correlated as all investors and funded institutions are forced to sell high quality assets in order to generate liquidity. This is not simply an issue for the shadow banking system, but is a feature of any market-based financial system where financial institutions' balance sheets are tied together with mark-to-market leverage constraints.

Ultimately, the underestimation of correlation by regulators, credit rating agencies, risk managers, and investors permitted financial institutions to hold too little capital against the credit and liquidity puts that underpinned the stability of the shadow banking system, which made these puts unduly cheap to sell. As investors also overestimated the value of private credit and liquidity enhancement purchased through these puts, the result was an excess supply of credit, which contributed significantly to asset price bubbles in real estate markets.

The AAA assets and liabilities that collateralized and funded the shadow banking system were a combination of the product of a range of securitization and secured lending techniques. Traditional banks' credit intermediation process "transplanted" into a securitization-based credit intermediation process has the potential to increase the *efficiency* of credit intermediation. However, securitization-based credit intermediation also creates agency problems which do not exist when these activities are conducted within a bank, as illustrated by Ashcraft and Schuermann (2007). If these agency

problems are not adequately mitigated with effective mechanisms, the financial system has weaker defenses against the supply of poorly underwritten loans and structured securities, and the end result could potentially be more severe than the failure of a single institution or even a group of institutions, since, as the financial crisis of 2007-2009 would demonstrate, it may involve the collapse of entire markets.

To the best of our knowledge, the term “shadow banking system” is attributed to McCulley (2007). In an article reflecting on the Federal Reserve Bank of Kansas City’s Jackson Hole economic symposium, McCulley points out that “unregulated shadow banks fund themselves with uninsured commercial paper, which may or may not be backstopped by liquidity lines from real banks. Thus, the shadow banking system is particularly vulnerable to runs—commercial paper investors refusing to re-up when their paper matures, leaving the shadow banks with a liquidity crisis—a need to tap their back-up lines of credit with real banks and/or to liquidate assets at fire sale prices.”

Overviews of the shadow banking system were provided by Pozsar (2008) and Adrian and Shin (2009). Pozsar (2008) was the first to catalogue different types of shadow banks, and to map and describe the asset and funding flows within the shadow banking system, while Adrian and Shin (2009) focused on the implications of the shadow banking system for financial regulation.

We use the label “shadow banking system” for this paper, but we believe that it is an incorrect and perhaps pejorative name for such a large and important part of the financial system. As illustrated in Figure 1 below, this system of public and private market participants has evolved and grown to a gross size of nearly \$20 trillion in March 2008, which was significantly larger than the liabilities of the traditional banking system. However, market participants as well as regulators failed to synthesize the rich detail of otherwise publicly available information on either the scale of the shadow banking system or its interconnectedness with the traditional banking system.

Figure 1: Shadow Bank Liabilities vs. Traditional Bank Liabilities, \$ trillion⁴

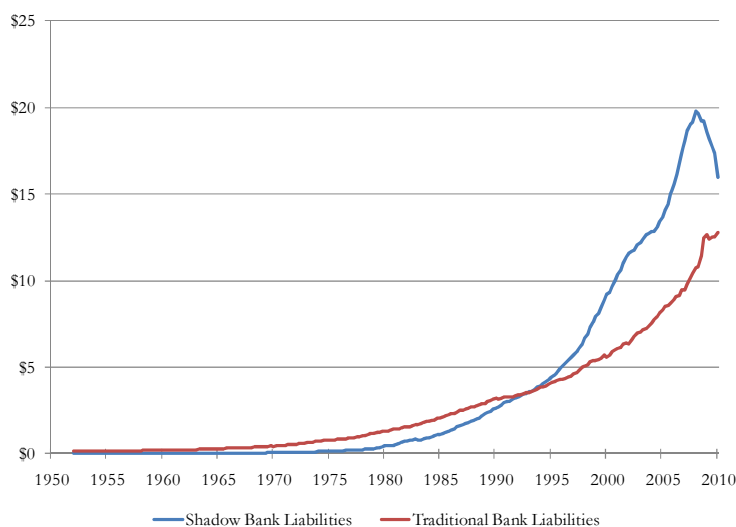

Source: Flow of Funds Accounts of the United States as of 2010:Q1 (FRB) and FRBNY.

While shadow banking activities certainly include activities which appear to have limited purpose other than regulatory capital arbitrage, it also includes a range of intermediation activities which appear to have significant economic value outside the traditional banking system. We prefer to label those parts of the shadow banking system that were driven not by regulatory arbitrage but by gains from specialization and comparative advantages over banks as the “parallel” banking system.

At a size of roughly \$16 trillion in the first quarter of 2010, the shadow banking system remains an important, albeit shrinking source of credit for the real economy. The official liquidity facilities and guarantee schemes introduced since the summer of 2007 helped make the \$5 trillion contraction in the size of the shadow banking system relatively orderly and controlled, thereby protecting the broader economy from the dangers of a collapse in the supply of credit as the financial crisis

⁴ The chart uses data from the Flow of Funds Accounts of the United States. Traditional liabilities refer to the Total Liabilities of Commercial Banking reported in line 19 of Table L109, which includes U.S.-chartered commercial banks, foreign banking offices in U.S., bank holding companies, and banks in U.S.-affiliated areas. Shadow Liabilities refer to the sum of Open Market Paper from line 1 of Table L208, Overnight Repo from FRBNY, Net Securities Lending from line 20 of Table L130, GSE Total Liabilities from line 21 of Table L124, GSE Total Pool Securities from line 6 of Table L125, Total Liabilities of ABS issuers from line 11 of Table L126, and Total Shares Outstanding of Money Market Mutual Funds from line 13 of Table L121.

unfolded. While these programs were only temporary in nature, given the still significant size of the shadow banking system and its inherent fragility due to exposure to runs by wholesale funding providers, it is imperative for policymakers to assess whether shadow banks should have access to official backstops permanently, or be regulated out of existence. While we do not attempt to answer this question in this paper, we aim to provide the reader with adequate background on the activities and workings of the shadow banking system to be a well-informed participant in that discussion.

Our monograph has four sections, but we only publish section one at this time. For the topics to be discussed in sections two to four, see the table of contents provided above. Section One (our present paper) discusses the genesis of the shadow banking system, defines its three sub-systems, describes its credit intermediation process, and explains how the responses of the Federal Reserve, the FDIC and the U.S. Treasury are tantamount to its complete backstop. Section One also provides conclusions and recommendations for the future of the shadow banking system.

Our conclusions are:

- (1) The volume of credit intermediated by the shadow banking system is of comparable magnitude to credit intermediated by the traditional banking system.
- (2) The shadow banking system can be subdivided into three sub-systems which intermediate different types of credit, in fundamentally different ways.
- (3) Some segments of the shadow banking system have emerged through various channels of arbitrage with limited economic value...
- (4) ...but equally large segments of it have been driven by gains from specialization. It is more appropriate to refer to these segments as the “parallel” banking system.
- (5) The collapse of the shadow banking system is not unprecedented in the context of the bank runs of the 19th and early 20th centuries: ...

- (6) ...private sector balance sheets will always fail at internalizing systemic risk. The official sector will always have to step in to help.
- (7) The shadow banking system was temporarily brought into the “daylight” of public liquidity and liability insurance (like traditional banks), but was then pushed back into the shadows.
- (8) Shadow banks will always exist. Their omnipresence—through arbitrage, innovation and gains from specialization—is a standard feature of all advanced financial systems.
- (9) Regulation by function is a more potent style of regulation than regulation by institutional charter. Regulation by function could have “caught” shadow banks earlier.

I.1 WHAT IS SHADOW CREDIT INTERMEDIATION?

The traditional banking system has three actors: savers, borrowers, and banks. Savers entrust their savings to banks in the form of deposits, which banks use to fund the extension of loans to borrowers. The process through which banks “recycle” savers’ deposits into loans is referred to as credit intermediation.

Relative to direct lending (that is, savers lending directly to borrowers), credit intermediation provides savers with information and risk economies of scale by reducing the costs involved in screening and monitoring borrowers and by facilitating investments in a more diverse loan portfolio.

Credit intermediation involves credit, maturity, and liquidity transformation.

Credit transformation refers to the enhancement of the credit quality of debt issued by the intermediary through the use of priority of claims. For example, the credit quality of senior deposits is better than the credit quality of the underlying loan portfolio due to the presence of junior equity.

Maturity transformation refers to the use of short-term deposits to fund long-term loans, which creates liquidity for the saver but exposes the intermediary to rollover and duration risks.

Liquidity transformation refers to the use of liquid instruments to fund illiquid assets. For example, a pool of illiquid whole loans might trade at a lower price than a liquid rated security secured by the same loan pool, as certification by a credible rating agency would reduce information asymmetries between borrowers and savers.

Credit intermediation is frequently enhanced through the use of third-party liquidity and credit guarantees, generally in the form of liquidity or credit put options. When these guarantees are provided by the public sector, credit intermediation is said to be *officially enhanced*. For example, credit

intermediation performed by depository institutions is enhanced by credit and liquidity put options provided through deposit insurance and access to central bank liquidity, respectively.

Exhibit 1 lays out the framework by which we analyze official enhancements. Thus, official enhancements to credit intermediation activities have four levels of “strength” and can be classified as either direct or indirect, and either explicit or implicit. A liability with direct official enhancement must reside on a financial institution’s balance sheet, while off-balance sheet liabilities of financial institutions are indirectly enhanced by the public sector. At the same time, there is no doubt about whether or not a liability with explicit enhancement would benefit from an official sector put, while it is unclear whether or not a liability enhanced with an implicit credit or put option would ultimately be protected.

Activities with direct and explicit official enhancement include for example the on-balance sheet funding of depository institutions; insurance policies and annuity contracts; the liabilities of most pension funds; and debt guaranteed through public-sector lending programs.⁵

Activities with direct and implicit official enhancement include debt issued or guaranteed by the government sponsored enterprises, which benefit from an implicit credit put to the taxpayer.

Activities with indirect official enhancement generally include for example the off-balance sheet activities of depository institutions like unfunded credit card loan commitments and lines of credit to conduits.

⁵ Depository institutions, including commercial banks, thrifts, credit unions, federal savings banks and industrial loan companies, benefit from federal deposit insurance and access to official liquidity backstops from the discount window. Insurance companies benefit from guarantees provided by state guaranty associations. Defined benefit private pensions benefit from insurance provided by the Pension Benefit Guaranty Corporation (PBGC), and public pensions benefit from implicit insurance provided by their state, municipal, or federal sponsors. The Small Business Administration, Department of Education, and Federal Housing Administration each operate programs that provide explicit credit enhancement to private lending.

Finally, activities with indirect and implicit official enhancement include asset management activities like bank-affiliated hedge funds and money market mutual funds, and securities lending activities of custodian banks.

Exhibit 1: The Topology of Pre-Crisis Shadow Banking Activities and Shadow Bank Liabilities

Institution	Direct Public Enhancement		Indirect Public Enhancement		Unenhanced
	Explicit	Implicit	Explicit	Implicit	
Depository Institutions <i>(Commercial Banks, Clearing Banks, LLCs)</i>	Insured deposits ¹ Non-deposit liabilities ²		Credit lines to shadow banks ⁹	Trust activities Tri-party clearing ¹⁰ Asset management Affiliate borrowing	
Federal Loan Programs <i>(DoE, SBA and FHA credit puts)</i>	Loan guarantees ³				
Government Sponsored Enterprises <i>(Fannie Mae, Freddie Mac, FHLMs)</i>		Agency debt	Agency MBS		
Insurance Companies	Annuity liabilities ⁴ Insurance policies ⁵				Securities lending CDS protection sold
Pension Funds	Unfunded liabilities ⁶				Securities lending
Diversified Broker-Dealers <i>(Investment Bank Holding Companies)</i>	Brokered deposits (ILCs) ⁷		CP ¹¹	Tri-party repo ¹²	MTNs Prime brokerage customer balances Liquidity puts (ABS, TOB, VRDO, ARS)
Mortgage Insurers					Financial guarantees
Monoline Insurers					Financial guarantees CDS protection sold on CDOs Asset management (GICs, SIVs, conduits)
Shadow Banks					
Finance Companies (Standalones, Captives)	Brokered deposits (ILCs) ⁷		CP ¹¹		Term ABS, MTNs
Single-Seller Conduits			ABCP ¹³		Extendible ABCP ¹⁸
Multi-Seller Conduits			ABCP ¹³	Extendible ABCP ¹⁷	Extendible ABCP ¹⁸
Hybrid Conduits			ABCP ¹³	Extendible ABCP ¹⁷	Extendible ABCP ¹⁸
TRS/Repo Conduits			ABCP ¹³		
Securities Arbitrage Conduits			ABCP ¹³	Extendible ABCP ¹⁷	Extendible ABCP ¹⁸
Structured Investment Vehicles (SIVs)			ABCP ¹³	Extendible ABCP ¹⁷ MTNs, capital notes	Extendible ABCP ¹⁸ Extendible ABCP ¹⁸ MTNs, capital notes
Limited Purpose Finance Companies			ABCP ¹³		Bi-lateral repo ¹⁵
Credit Hedge Funds (Standalones)			Bi-lateral repo ¹⁴		Bi-lateral repo ¹⁵
Money Market Intermediaries <i>(Shadow Bank "Depositors")</i>					
Money Market Mutual Funds					\$1 NAV
Overnight Sweep Agreements					\$1 NAV
Cash "Plus" Funds					\$1 NAV
Enhanced Cash Funds					\$1 NAV
Ultra-Short Bond Funds					\$1 NAV
Local Government Investment Pools (LGIPs)					\$1 NAV
Securities Lenders					\$1 NAV
European Banks <i>(Landsbankas, etc.)</i>	State guarantees ⁸	ABCP ¹⁶	Credit lines to shadow banks ¹⁷		

Source: Shadow Banking (Pozsar, Adrian, Ashcraft, Boesky (2010))

In addition to credit intermediation activities that are enhanced by liquidity and credit puts provided by the public sector, there exist a wide range of credit intermediation activities which take place without official credit enhancements. These credit intermediation activities are said to be *unenanced*.

For example, the securities lending activities of insurance companies, pension funds and certain asset managers do not benefit from access to official liquidity.

We define shadow credit intermediation to include all credit intermediation activities that are (1) implicitly enhanced, (2) indirectly enhanced or (3) unenhanced by official guarantees. Financial entities that engage exclusively in shadow credit intermediation are shadow banks.⁶

I.2 THE SHADOW CREDIT INTERMEDIATION PROCESS

The shadow banking system, like the traditional banking system, has three actors: savers, borrowers, and—instead of banks—specialist non-bank financial intermediaries, or shadow banks. Unlike in the traditional banking system, however, savers do not place their funds with banks, but rather with money market mutual funds and similar funds, which invest these funds in the liabilities of shadow banks, which offer a spectrum of seniority and duration, and correspondingly, risk and return. Borrowers still get loans, leases and mortgages, but not only from depository institutions, but also from entities like finance companies.

Like the traditional banking system, the shadow banking system conducts credit intermediation. However, unlike the traditional banking system, where credit intermediation is performed “under one roof”—that of a bank—in the shadow banking system it is performed through a daisy-chain of non-bank financial intermediaries, and through a granular set of steps. These steps essentially amount to the “vertical slicing” of traditional banks’ credit intermediation process and include (1) loan origination, (2) loan warehousing, (3) ABS issuance, (4) ABS warehousing, (5) ABS CDO issuance, (6) ABS “intermediation” and (7) wholesale funding.

⁶ In other words, we define shadow banks as financial intermediaries that conduct maturity, credit, and liquidity transformation without access to central bank liquidity or public sector credit guarantees.

The shadow banking system performs these steps of shadow credit intermediation in a strict, sequential order with each step performed by a specific type of shadow bank and through a specific funding technique (for a set of stylized examples, see Exhibit 2).

Exhibit 2: The Steps, Entities and Funding Techniques Involved in Shadow Credit Intermediation - Illustrative Examples

	Function	Shadow Banks	Shadow Banks' Funding*
Step (1)	Loan Origination	Finance companies	CP, MTNs, bonds
Step (2)	Loan Warehousing	Single and multi-seller conduits	ABCP
Step (3)	ABS Issuance	SPVs, structured by broker-dealers	ABS
Step (4)	ABS Warehousing	Hybrid, TRS/repo conduits, broker-dealers' trading books	ABCP, repo
Step (5)	ABS CDO Issuance	SPVs, structured by broker-dealers	ABS CDOs, CDO-squareds
Step (6)	ABS Intermediation	LPFCs, SIVs, securities arbitrage conduits, credit hedge funds	ABCP, MTN, repo
Step (7)	Wholesale Funding	2(a)-7 MMMFs, enhanced cash funds, securities lenders, etc	\$1 NAV shares (shadow bank "deposits")

*Funding types highlighted in red denote securitized funding techniques. Securitized funding techniques are *not* synonymous with secured funding.

Source: Shadow Banking (Pozsar, Adrian, Ashcraft, Boesky (2010))

First, loan origination (that of auto loans and leases, or non-conforming mortgages, for example) is performed by finance companies which are funded through commercial paper (CP) and medium-term notes (MTNs).

Second, loan warehousing is conducted by single- and multi-seller conduits and is funded through asset-backed commercial paper (ABCP).

Third, the pooling and structuring of loans into term asset-backed securities (ABS) is conducted by broker-dealers' ABS syndicate desks.

Fourth, ABS warehousing is facilitated through trading books and is funded through repurchase agreements (repo), total return swaps or hybrid and repo/TRS conduits.

Fifth, the pooling and structuring of ABS into CDOs is also conducted by broker-dealers' ABS syndicate desks.

Sixth, ABS intermediation is performed by limited purpose finance companies (LPFCs), structured investment vehicles (SIVs), securities arbitrage conduits and credit hedge funds, which are funded in a variety of ways including for example repo, ABCP, MTNs, bonds and capital notes.

Seventh, the funding of all the above activities and entities is conducted in wholesale funding markets by funding providers such as regulated and unregulated money market intermediaries (for example, 2(a)-7 MMMFs and enhanced cash funds, respectively) and direct money market investors (such as securities lenders). In addition to these *cash* investors, which fund shadow banks through short-term repo, CP and ABCP instruments, fixed income mutual funds, pension funds and insurance companies also fund shadow banks by investing in their longer-term MTNs and bonds.

Exhibit 3: The Shadow Credit Intermediation Process

The shadow credit intermediation process consists of distinct steps. These steps for a credit intermediation chain that depending on the type and quality of credit involved may involve as little as 3 steps and as much as 7 or more steps. The shadow banking system conducts these steps in a strict sequential order. Each step is conducted by specific types of financial entities, which are funded by specific types of liabilities (see Table 2).

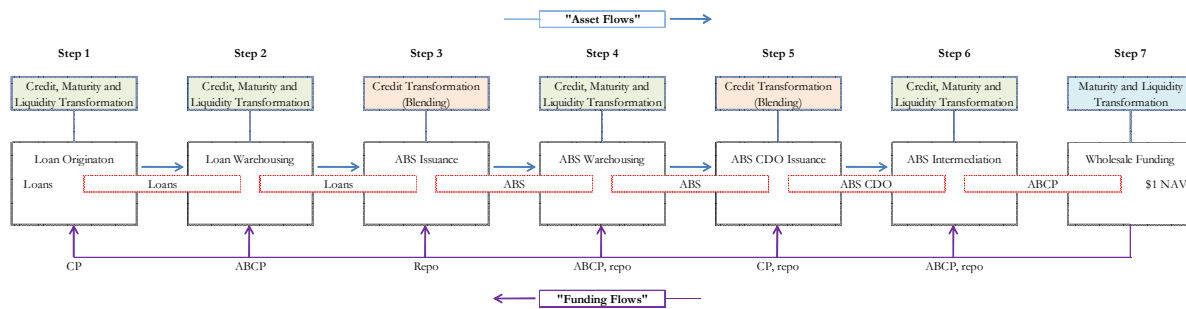

Source: Shadow Banking (Pozsar, Adrian, Ashcraft, Boesky (2010))

The shadow credit intermediation process binds shadow banks into a network (see Exhibit 3), which forms the backbone of the shadow banking system, and conducts an economic role that is analogous to the credit intermediation process performed by banks in the traditional banking system. In essence, the shadow banking system decomposes the simple process of deposit-funded, hold-to-maturity lending conducted by banks, into a more complex, wholesale-funded, securitization-based lending process that involves a range of shadow banks.

Through this intermediation process process, the shadow banking system transforms risky, long-term loans (subprime mortgages, for example) into seemingly credit-risk free, short-term, money-like instruments, such as the \$1, stable net asset value (NAV) shares that are issued by 2(a)-7 money market mutual funds, and are “withdrawable” on demand, much like a demand deposit at a bank. This crucial point is illustrated by the first and last links in Exhibit 3 depicting the asset and funding flows of the credit intermediation process of the shadow banking system.

Importantly, not all shadow credit intermediation chains involve all seven steps, and some might involve even more steps. For example, an intermediation chain might stop at “Step 2” if a pool of prime auto loans is sold by a captive finance company to a bank-sponsored multi-seller conduit for term warehousing purposes. In another example, ABS CDOs could be further repackaged into a CDO², which would elongate the intermediation chain to include eight steps. Typically, the poorer an underlying loan pool’s quality at the beginning of the chain (for example a pool of subprime mortgages originated in California in 2006), the longer the credit intermediation chain that would be required to “polish” the quality of the underlying loans to the standards of money market mutual funds and similar funds. As a rule of thumb, the intermediation of low-quality long-term loans (non-conforming mortgages) involved all seven or more steps, whereas the intermediation of high-quality short- to medium-term loans (credit card and auto loans) involved usually three to four steps (and rarely more). Whether an intermediation chain is shorter or longer than seven steps it always starts with origination and ends with wholesale funding, and each shadow bank appears only once in the shadow credit intermediation process.

I.3 THE INSTRUMENTS OF SHADOW CREDIT INTERMEDIATION

There are at least four different ways in which the securitization-based, shadow credit intermediation process can not only lower the cost and improve the availability of credit, but also reduce volatility of the financial system as a whole.

First, securitization involving real credit risk transfer is an important way for an issuer to limit concentrations to certain borrowers, loan types and geographies on its balance sheet.

Second, term asset-backed securitization (ABS) markets are valuable not only as a means for a lender to diversify its sources of funding, but also to raise long-term, maturity-matched funding to better manage its asset-liability mismatch than it could by funding term loans with short-term deposits.

Third, securitization permits lenders to realize economies of scale from their loan origination platforms, branches, call centers and servicing operations that are not possible when required to retain loans on balance sheet.

Fourth, securitization is a potentially promising way to involve the market in the supervision of banks, by providing third-party discipline and market pricing of assets that would be opaque if left on the banks' balance sheets.

The products of the securitization-based, shadow credit intermediation process are a wide range of structured credit assets. To better understand them—ABCP, ABS and ABS CDOs—we offer a *functional* matrix of asset-backed securities (see Exhibit 4). The two dimensions of the matrix are (1) funding type and (2) collateral type. And according to these dimensions, structured credits might either be short-term (maturity mismatched) or term (maturity matched) and they may reference loans and bonds (1st order securitizations) or structured credit securities (2nd order securitizations).

Exhibit 4: The Functional Role and Liquidity/Credit Put Features of Various Forms of Securitization

		Funding Type		Funding Type	
		Maturity Mismatched	Maturity Matched	Maturity Mismatched	Maturity Matched
Collateral Type	Whole Loans/Bonds	Step 1	Step 2	Step 1	Step 2
		Securitization Type: ABCP, TOB, VRDO Function: Warehousing/Term Funding of Whole Loans/Bonds Issuers: Single and Multi-Seller Conduits, as well as TOBs and VRDOs	Securitization Type: ABS, CLO, CDO (1st order) Function: Term Funding of Whole Loans Issuers: SPVs	Securitization Type: ABCP, TOB, VRDO Liquidity Put: Yes Credit Put: Yes (credit lines, wraps, asset sales)	Securitization Type: ABS, CLO, CDO (1st order) Liquidity Put: Static Pools - No Master Trusts - Yes Credit Put: Static Pools - No Master Trusts - Yes
	Securitized Loans/Bonds	Step 3	Step 4	Step 3	Step 4
		Securitization Type: ABCP Function: Warehousing/Term Funding of ABS, CLOs and CDOs Issuers: LPFCs, SIVs, Securities Arbitrage Conduits	Securitization Type: ABS CDOs (2nd order) Function: Term Funding of ABS, CLOs and CDOs Issuers: SPVs	Securitization Type: ABCP Liquidity Put: Yes Credit Put: Yes (credit lines, wraps, asset sales)	Securitization Type: ABS CDOs (2nd order) Liquidity Put: No Credit Put: Yes (wraps, asset sales)
				Collateral Type	Whole Loans/Bonds
					Securitized Loans/Bonds

Source: Shadow Banking (Pozsar, Adrian, Ashcraft, Boesky (2010))

Following this matrix along a "Z"-path, starting from the upper left hand corner, one can track the typical life cycle of a loan through the shadow credit intermediation process, and the many different forms of securitization it may pass through in the process (see the left-hand panel of Exhibit 4).⁷

Thus, loan pools entering the securitization process (Step 1) are first securitized in the form of ABCP via SPVs called single- and multi-seller conduits. Loans that are securitized this way are meant to be funded this way either through maturity or only temporarily for warehousing purposes. These types of securitization, and the entities that rely on them for funding facilitate, credit, maturity and liquidity transformation, just like traditional banks.

Warehoused loans are taken out of the conduit following an accumulation period, and are put into a term ABS structure (Step 2). The principal differences between the ABCP and term ABS funding of loans are the maturity mismatch and rollover risks inherent in the former and the maturity-matched

⁷ As noted above, loan pools do not necessarily pass through each of these steps.

nature of the latter. As such, term ABS conducts credit and liquidity transformation, but no maturity transformation (or at least not the type that involves rollover risks).⁸

Term ABS in turn are often funded through ABCP as well (Step 3), or through other alternatives, such as repo or sales to real money accounts. ABCP issued against ABS collateral is a form of re-securitization (or 2nd order securitization). Similar to loans, ABS funded through ABCP conduits are either intended to be funded that way through maturity (securities arbitrage conduits) or only for warehousing purposes (repo/TRS conduits). These types of securitization, and the entities that rely on them for funding, also conduct credit, maturity and liquidity transformation, just like banks.

Finally, warehoused term ABS are taken out of the warehouse conduits after an accumulation phase and put into an ABS CDO. ABS CDOs, like ABCP issued against ABS collateral, were a form of re-securitization, but unlike the prior example, ones without any maturity mismatch. Similar to term ABS, ABS CDOs conduct credit and liquidity transformation, but no maturity transformation. The life-cycle of loans does not necessarily end here, as ABS CDOs might be repackaged into CDO²s and CDO³s, which were CDOs of ABS CDOs and CDOs of CDOs of ABS CDOs, respectively.

Thus, the structured credit securities that are “manufactured” through the shadow credit intermediation process can be classified into four groups. These are (1) short-term, maturity mismatched securitization in the form of ABCP; (2) term, maturity matched securitizations in the form of term ABS; (3) short-term, maturity mismatched re-securitizations, again, in the form of ABCP; and (4) term, maturity matched re-securitizations in the form of ABS CDOs.

⁸ The AAA tranches of term ABS are typically time-tranched into A1, A2, A3 and A4 tranches. The A1 tranche is a money market tranche that is expected to pay off before the A2, A3 and A4 tranches, which tend to have durations of between 1-2, 2-3 and 3-4 years, respectively. The prioritization of its cash flows to the A1 tranche can be considered one form of maturity transformation. This maturity transformation does not involve rollover risks, however, like those involved in classic bank activities of funding long-term loans with short-term deposits, or the ones involved in multi-seller ABCP conduits, which fund long-term loans with short-term ABCP that needs to be rolled frequently. The weighted average maturity (WAM) of all the tranches of the term ABS (including the equity tranche) is equal to the WAM of the pool of loans it references. So while some of the senior-most tranches of the ABS may have a shorter maturity than the pool (like the A1 tranche discussed above), the ABS as a whole conducts *no* maturity transformation.

institution can specialize in credit transformation without maturity or liquidity transformation, or liquidity transformation without credit and maturity transformation. The shadow banking system can thus be interpreted as a system which reallocates the three functions of banks across a variety of specialist, non-bank financial intermediaries, each of which has a distinctive comparative advantage.

Indeed, the four different securitization types discussed above—and the differing degrees to which they conduct credit, maturity and liquidity transformation—correspond to specific types of non-bank financial intermediaries. Thus, ABCP funding loans are typically issued by single- and multi-seller conduits; term ABS are typically issued by banks and finance companies; ABCP funding term ABS is issued typically by securities arbitrage, hybrid, and repo/TRS conduits, as well as limited purpose finance companies (LPFCs) and structured investment vehicles (SIVs); finally, ABS CDOs are typically issued by broker-dealers to purge ABS warehouses from unsellable wares.¹⁰

The four different securitization types, and the entities that issue them, frequently rely on credit and liquidity puts to mitigate the risks of the credit, maturity and liquidity transformation inherent in their credit intermediation activities. Since these puts are provided by the private sector, these entities and forms of securitization are shadow banks and shadow bank liabilities, respectively.

The credit and liquidity puts often come in the form of backup liquidity lines from banks for ABCP issuers. For term ABS and ABS CDOs such puts take the form of credit guarantees, wraps and credit default swaps (CDS) provided by a range of entities including mortgage insurers, mono-line insurers, diversified insurance companies, credit derivative product companies and credit hedge

¹⁰ Securitization was designed to provide transparent and efficient pricing of illiquid and opaque assets. However, the growth of ABS CDOs not only masked but also created an underlying pricing problem in the primary ABS market (Adelson and Jacob, (2007)). In particular, in the early days of securitization, the junior tranches of home equity deals were purchased by real money investors. However, these investors were pushed aside by the aggressive buying of ABS CDOs, which resided on the trading books of large broker-dealers. The mispricing of the junior ABS tranches permitted issuers to distribute loan pools with increasingly worse underwriting. ABS CDOs suffered from the same underlying problem as the underlying ABS, which required the creation of CDO-squared products.

funds. For repo investors in the secured lending part of the shadow banking system, the puts come from tri-party clearing banks through daylight unwinds of overnight repos (right-hand panel of Exhibit 4).

I.4 THE SHADOW BANKING SYSTEM

We identify the three distinct subgroups of the shadow banking system. These are: (1) the government-sponsored shadow banking sub-system; (2) the “internal” shadow banking sub-system; and (3) the “external” shadow banking sub-system.

I.4.1 The Government-Sponsored Shadow Banking Sub-System

The seeds of the shadow banking system were sown nearly 80 years ago, with the creation the government-sponsored enterprises (GSE), which are comprised of the FHLB system (1932), Fannie Mae (1938) and Freddie Mac (1970).

The GSEs have dramatically changed the way banks fund themselves and conduct lending: the FHLBs were the first providers of what we refer to today as the term warehousing of loans, and Fannie Mae and Freddie Mac were cradles of the originate-to-distribute model of securitized credit intermediation.

Like banks, the GSEs funded their loan and securities portfolios with a maturity mismatch. Unlike banks, however, the GSEs were not funded using deposits, but through capital markets, where they issued short and long-term agency debt securities to money market investors, such as money market mutual funds, and real money investors such as fixed income mutual funds, respectively. The funding “utility” functions performed by the GSEs for banks and the way they funded themselves were the models for what we refer today to as the wholesale funding market (see Exhibit 6).

Exhibit 6: The Steps, Entities and Funding Techniques Involved in the GSEs' Credit Intermediation Process

	Function	Shadow Banks	Shadow Banks' Funding*
Step (1)	Mortgage Origination	Commercial banks	Deposits, CP, MTNs, bonds
Step (2)	Mortgage Warehousing	FHLBs	Agency debt and discount notes
Step (3)	ABS Issuance	Fannie Mac, Freddie Mac through the TBA market	Agency MBS (passthroughs)
Step (4)	ABS Warehousing	Broker-dealers' trading books	ABCP, repo
Step (5)	ABS CDO Issuance	Broker-dealer agency MBS desks	CMOs (res securitizations)
Step (6)	ABS Intermediation	GSE retained portfolios	Agency debt and discount notes
Step (7)	Wholesale Funding	2(a)-7 MMMFs, enhanced cash funds, securities lenders	\$1 NAV shares (GSE "deposits")

*Funding types highlighted in red denote securitized funding techniques. Securitized funding techniques are *not* synonymous with secured funding.

Source: Shadow Banking (Pozsar, Adrian, Ashcraft, Boesky (2010))

The GSEs embodied four techniques:

First, term loan warehousing provided to banks by the FHLBs.

Second, credit risk transfer and transformation through credit insurance provided by Fannie Mae and Freddie Mac.

Third, originate-to-distribute securitization functions provided for banks by Fannie Mae and Freddie Mac.

Fourth, maturity transformation conducted through the GSE retained portfolios, which essentially operated as quasi-government SIVs.¹¹

Over the past thirty years or so, these four techniques became widely adopted by banks and non-banks in their credit intermediation and funding practices, were extended to a broad range of loans, adopted globally, and performed in a variety of different ways. The adaptation of these concepts fundamentally changed the banks-based, originate-to-hold credit intermediation process and gave rise to the securitization-based, originate-to-distribute credit intermediation process.

¹¹ Not unlike SIVs, all GSE debt and guarantees are off balance sheet to the federal government. No provisions are made for capital needs and balance sheet risks, and the GSEs are excluded from the federal budget. Their off-balance sheet nature is the same as those of bank sponsored SIVs and securities arbitrage conduits that had to be rescued by their sponsor banks. The GSE's are off-balance sheet shadow banks of the federal government.

Fannie Mae was privatized in 1968 in order to reduce burgeoning government debt due to the Vietnam War at the time. Privatization removed Fannie from the government's balance sheet, yet it continued to have a close relationship with it and carry out certain policy mandates and enjoyed an implicit government guarantee. This was similar to the way off-balance sheet private shadow banks were backstopped through liquidity guarantees by their sponsoring banks. Fannie and Freddie's conflicts of managing shareholders' interest with their mission ultimately lead to their demise and "re-nationalization" in the fall of 2008 and the eventual de-listing of their stocks on June 16, 2010.

The government-sponsored shadow banking sub-system is not involved in loan origination, only loan processing and funding.¹² These entities qualify as shadow banks to the extent that they were involved in the traditional bank activities of credit, maturity, or liquidity transformation, but without actually being chartered as banks and without having a meaningful access to a lender of last resort and an *explicit* insurance of their liabilities by the federal government (see Exhibit 7).¹³

I.4.2 The "Internal" Shadow Banking Sub-System

While the seeds of shadow banking have been sewn over 80 years ago, the crystallization of shadow banking activities into a full-fledged system is a phenomenon of the past 30 years. The principal drivers of the growth of the shadow banking system have been the transformation of the largest banks since the early-1980s from low return on-equity (RoE) utilities that originate loans and hold and fund them until maturity with deposits, to high RoE entities that originate loans in order to warehouse and later securitize and distribute them, or retain securitized loans through off-balance sheet asset management vehicles. In conjunction with this transformation, the nature of banking

¹² The GSEs were prohibited from loan origination by design. They were meant to create a secondary market for mortgages to facilitate interstate capital flows for a national mortgage market.

¹³ Note that Fannie and Freddie had \$2.5 and \$2.25 billion in credit lines from the U.S. Treasury. While liquidity backstops of sorts, these credit lines were quite small compared to the size of their balance sheets.

Exhibit 7: The Government-Sponsored Shadow Banking System

The shadow credit intermediation process, and the shadow banking system were to a great extent inspired by the government sponsored enterprises, namely the FHLM system, Fannie Mae and Freddie Mac. The GSEs are creations of lawmakers and are **off-balance sheet**, **"shadow banks"** of the U.S. Federal Government. The GSEs that make up the government-sponsored shadow banking system perform similar functions to term multi-seller conduits, credit risk repositories, and LPRs and SIVs in the "private" shadow banking system. Thus, similar to multi-seller conduits, the FHLM system provides term loan warehousing for conforming mortgages (and other loans) to member commercial banks, similar to monoline insurers, Fannie Mae and Freddie Mac provide guarantees on the loans that back Agency MBS, turning them into credit risk-free rate products, and similar to SIVs or LPRs, the GSE retained portfolios conduct maturity transformation on pools of mortgages and private-label term ABS. The credit intermediation process that goes through the government-sponsored shadow banking sub-system starts with commercial banks that originate conforming mortgages. These are either (1) funded with the FHLMs through maturity, or (2) are sold in the "TBA" market in order to be packaged into Agency MBS. As the loans pass through the TBA process, Fannie or Freddie provide guarantees on the loan pools, assuming the credit risk out of them. Some of the Agency MBS might end up being packaged into collateralized mortgage obligations (CMOs) which time-tranche the underlying cash-flows of mortgage pools. The short-dated tranches of CMOs are sold to 2(a)-7 MDMs and other funds. Similarly, the GSE retained portfolios are funded through a mix of short-dated Agency discount notes (the GSE equivalent of private CP and ARCP) and Agency debt (the GSE equivalent of private MTNs and bonds) that are also sold to MDMs and real money accounts, respectively.

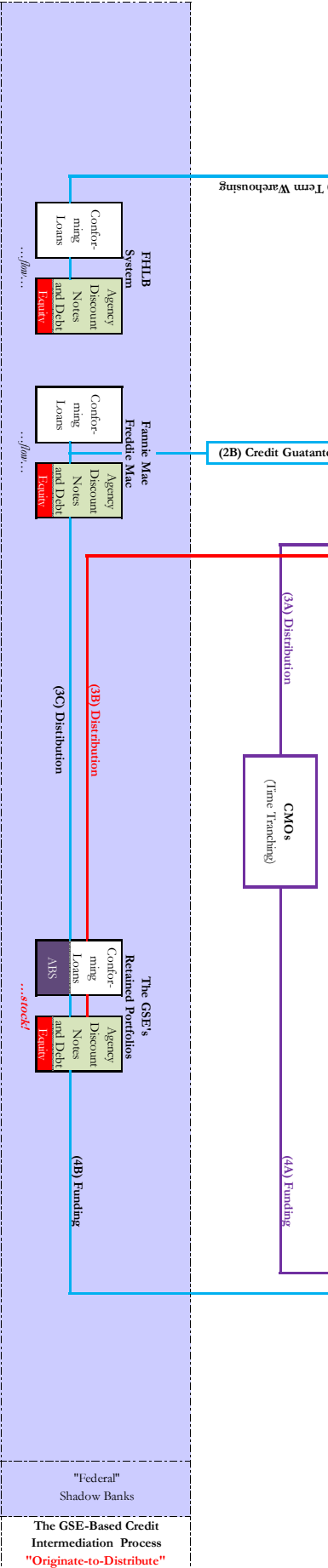
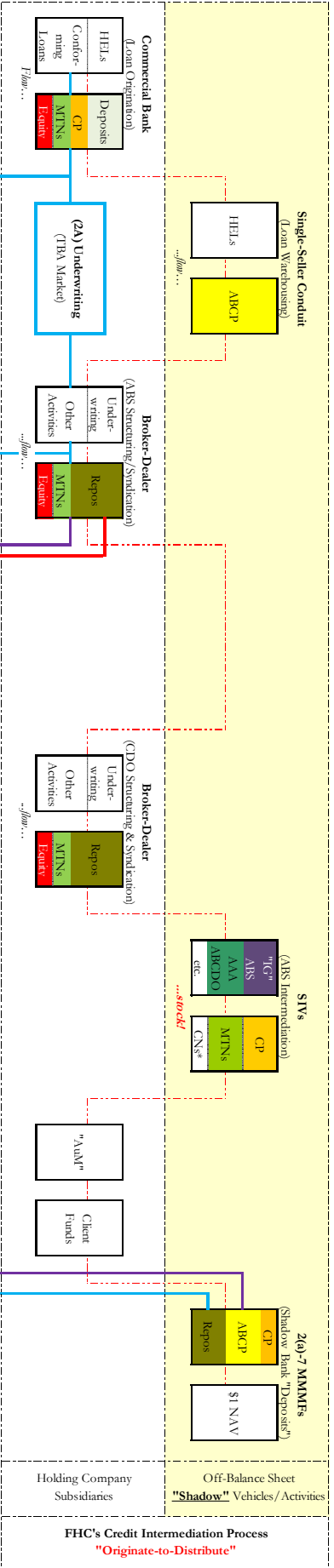
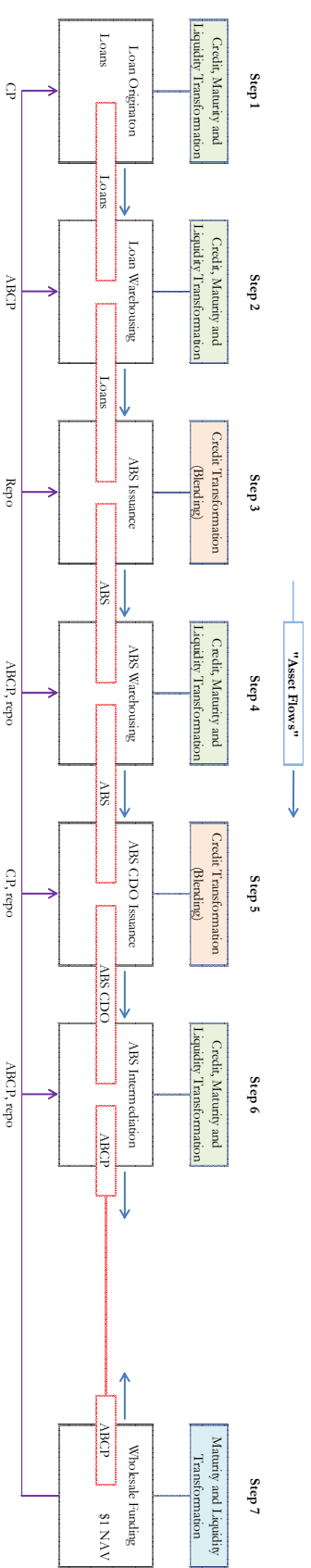

changed from a credit-risk intensive, deposit-funded, spread-based process, to a less credit-risk intensive, but more *market*-risk intensive, wholesale funded, fee-based process.

The transformation of banks occurred within the legal framework of financial holding companies (FHC), which through the acquisition of broker-dealers and asset managers, allowed large banks to transform their traditional process of hold-to-maturity, spread-banking to a more profitable process of originate-to-distribute, fee-banking. The FHC concept was legitimized by the abolishment of the Glass-Steagall Act of 1932, and codified by the Gramm-Leach-Bliley Act of 1999.

The genesis of the FHC concept can be traced back to the gradual erosion of banks' "specialness"¹⁴ since the 1970s on both their asset and liability sides. This erosion occurred due to the entry and growth of an army of specialist non-banks since the late-1970s into the businesses of (1) credit intermediation (for example, finance companies) and (2) retail and institutional cash management (for example, money market mutual funds), each of them representing important financial innovations and examples of gains from specialization. Combined with the high costs and restrictions imposed by regulators on banks, growing competition from specialist non-banks put increasing pressure on banks' profit margins. Interestingly, banks dealt with these pressures by starting to acquire the very specialist non-bank entities that were posing a competitive threat, and gradually shifted many of their activities related to credit intermediation into these newly acquired, less-regulated, non-bank subsidiaries—or shadow banks. Eventually, what was regulated, restricted and "innovated" out of the banks found its way back into them through acquisitions.

Through these acquisitions banks changed the way they lent, and became much like manufacturing companies, originating loans with the intention of selling them rather than holding them through maturity. Manufacturers make products to sell, not to keep them, and the price at which they decide

¹⁴ http://www.minneapolisfed.org/publications_papers/pub_display.cfm?id=3527

to make products is determined by what they are worth in the market. An additional development that was instrumental in changing banks' behavior was the rise of an active secondary loan market, which helped banks determine the true cost of holding loans versus selling them.

Over time, the largest banks became more willing to lend if they knew they could sell loans at a gain. The rise of this approach to lending elevated the prominence of the portfolio management function within banks in the management of bank balance sheets, overtaking the treasury function as the "heart" of the bank. Portfolio management started to decide which assets were retained and which assets were sold, and charged originators (both internal and external) the replacement cost of balance sheet for warehoused assets. Modern banks "rent" their balance sheets, and set their "rents" based on the replacement cost of their balance sheets (see, for example, Dudley (2007)).¹⁵

This change in the nature of banking was initially "inspired" by the securitization process of conforming mortgages through the GSEs, and was extended to virtually all forms of loans and "perfected" into a securitization-based, shadow credit intermediation process over time.

The shadow credit intermediation process involves the vertical (functional) slicing of the traditional bank lending process into distinct steps, and the horizontal (risk and term) tranching of loan pools, whereby each of these functions and activities were conducted from those on- or off-balance sheet corners of an FHC and in a manner that required the least amount of capital to be held against them. Similarly, the funding of the term and risk slices of loan pools was conducted from those corners of the holding company and in a manner that was the most capital efficient. Due to the global nature of most FHCs, these activities were also conducted from jurisdictions that had the most lenient oversight of certain types of functions, with the origination, warehousing and

¹⁵ <http://www.newyorkfed.org/newsevents/speeches/2007/dud071017.html>

securitization of loans conducted mainly from New York, and the funding of final products (ABS intermediation) conducted mainly from London and other offshore centers.

I.4.2.1 The Credit Intermediation Process of Financial Holding Companies

The vertical and horizontal slicing of credit intermediation was conducted through the application of a range of off-balance sheet securitization and asset management techniques (see Exhibit 8), which enabled FHC-affiliated banks to conduct lending with less capital than if they had retained loans on their balance sheets. This process contributed greatly to the improved RoE of banks, or more precisely, the RoE of their holding companies.

Exhibit 8: The Steps, Entities and Funding Techniques Involved in FHCs' Credit Intermediation Process

	Function	Shadow Banks	Shadow Banks' Funding*
Step (1)	Loan Origination	Commercial bank subsidiary	Deposits, CP, MTNs, bonds
Step (2)	Loan Warehousing	Single/multi-seller conduits	ABCP
Step (3)	ABS Issuance	SPVs, structured by broker-dealer subsidiary	ABS
Step (4)	ABS Warehousing	Hybrid, TRS/repo conduits, broker-dealers' trading books	ABCP, repo
Step (5)	ABS CDO Issuance	SPVs, structured by broker-dealer subsidiary	ABS CDOs, CDO-squareds
Step (6)	ABS Intermediation	SIVs, internal credit hedge funds (asset management)	ABCP, MTN, capital notes and repo
Step (7)	Wholesale Funding	2(a)-7 MMMFs, enhanced cash funds, securities lending subs.	\$1 NAV shares (shadow bank "deposits")

*Funding types highlighted in red denote securitized funding techniques. Securitized funding techniques are *not* synonymous with secured funding.

Source: Shadow Banking (Pozsar, Adrian, Ashcraft, Boesky (2010))

Thus, whereas a traditional bank would conduct the origination, funding and risk management of loans on one balance sheet (its own), an FHC would (1) originate loans in its bank subsidiary, (2) warehouse and accumulate loans in an off-balance sheet conduit that is managed by its broker-dealer subsidiary, is funded through wholesale funding markets, and is liquidity-enhanced by the bank, (3) securitize loans via its broker-dealer subsidiary by transferring them from the conduit into a bankruptcy-remote SPV, and (4) fund the safest tranches of structured credit assets in an off-balance sheet ABS intermediary (a structured investment vehicle (SIV), for example) that was managed from

Exhibit 9: The Credit Intermediation Process of Bank Holding Companies

The credit intermediation process of Financial Holding Companies flows through a chain of subsidiaries and off-balance sheet vehicles (shadow banks), and is funded in capital markets. This intermediation chain enhances the efficiency of bank equity for various reasons. If markets freeze and the FHC's subsidiaries have to "onboard" their normally off-balance sheet assets and activities, capital **efficiency** can quickly become capital **deficiency**, with systemic consequences. The process described here is an **originate-to-distribute** model of non-conforming mortgages, where the originating banks and the broker-dealers that slice and dice mortgages into ABS and ABS CDOs do not retain any first loss pieces along the intermediation chain.

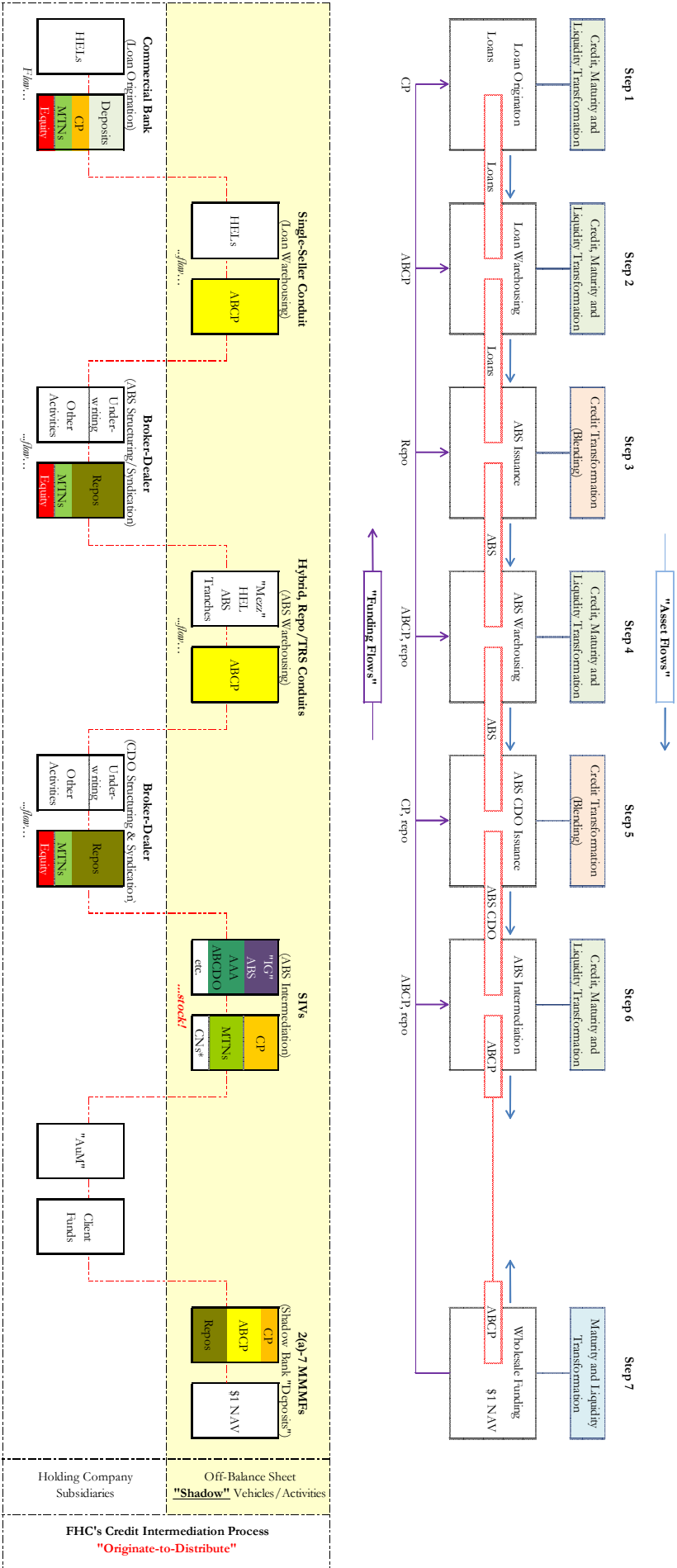

Source: Shadow Banking (Pozsar, Adrian, Askerari, Boscary (2010))

the asset management subsidiary of the holding company, is funded through wholesale funding markets and is backstopped by the bank (see Exhibit 9).¹⁶

Note that the just described credit intermediation process does not refer to the “life-cycle” of a pool of loans originated by an FHC’s bank—legally, a self-originated loan pool could not pass through this process. Rather it refers to the processing and intermediation of loans originated by third parties on a system-wide level. The example highlights three important aspects of the changed nature of lending in the U.S. financial system, especially for residential and commercial mortgage credit.

First, the process of lending and the uninterrupted flow of credit to the real economy is no longer reliant on banks only, but on a process that spanned a network of banks, broker-dealers, asset managers and shadow banks—all under the umbrella of FHCs—funded through wholesale funding and capital markets globally.

Second, a bank subsidiary’s only direct involvement in an FHC’s credit intermediation process is at the loan origination level. Its indirect involvements are broader, however, as it acts as a lender of last resort to the subsidiaries and off-balance sheet shadow banks involved in the warehousing and processing of loans, and the distribution and funding of structured credit securities, in case they cannot obtain funding in wholesale funding markets. Strikingly, despite the fact that FHC’s credit intermediation process depended on at least four entities other than the bank, only the bank subsidiary of an FHC had access to the Federal Reserve’s discount window and benefited from liability (deposit) insurance from the government, but not the other subsidiaries or their shadow banks (hence “internal” shadow banking sub-system). Moreover, restrictions govern the amount of

¹⁶ Some ABS intermediaries brought long-term capital to invest in structured credit securities (SIVs), but some brought no risk absorbing capital and engaged purely in regulatory arbitrage. Note that although SIVs were funded with third-party capital, U.S. banks would not be able to get securitizations off their own balance sheets if sold them to a SIV that was “sponsored, managed and advised” by the bank.

funds a bank can “transfer” to other subsidiaries of the holding company, not only in the normal course of business, but also if it borrows from the discount window.

Third, lending became a capital efficient, fee-rich, high-RoE endeavor for originators, structurers and ABS investors, enabled by the symbiosis between banks, broker-dealers, asset managers and shadow banks. As the financial crisis of 2007-2009 would show, however, the capital efficiency of the process was highly dependent on liquid wholesale funding and debt capital markets globally, and that any paralysis in markets could turn banks’ capital *efficiency* to capital *deficiency* virtually overnight, with systemic consequences.

This interpretation of the workings of FHCs is radically different from the one that emphasizes the benefits of FHCs as “financial supermarkets”. According to that widely-held view, the diversification of the holding companies’ revenues through broker-dealer and asset management activities makes the banking business more stable, as the holding companies’ banks, if need be, could be supported by net income from other operations during times of credit losses. In our interpretation, the broker-dealer and asset management activities are not parallel, but serial and complementary activities to FHCs’ banking activities.

The serial as opposed to parallel nature of the linkage between the broker-dealer and asset management subsidiaries and the commercial bank subsidiary within an FHC is not necessarily bad, and neither is the credit intermediation process described above. However, they became bad (in some cases), as capital requirements to manage these linkages and conduct the process prudently were circumvented through three channels of arbitrage. These were: (1) cross-border regulatory systems arbitrage, (2) regulatory, tax and economic capital arbitrage, and (3) ratings arbitrage.

These arbitrage opportunities emerged from the fractured nature of the global financial regulatory framework; the dependence of capital adequacy rules (Basel II) on credit ratings; and a collection of

one-off, uncoordinated decisions by accounting and regulatory bodies regarding the accounting and regulatory capital treatment of certain exposures and lending and asset management activities.

I.4.2.2 The Shadow Banking Activities of European Banks

Some parts of the “internal” shadow banking sub-system specialized in certain steps of the shadow credit intermediation process. These included primarily *undiversified* European banks, whose involvement in shadow credit intermediation was limited to loan warehousing, ABS warehousing and ABS intermediation, but not origination, structuring, syndication and trading (see Exhibit 10).¹⁷

Exhibit 10: The Steps, Entities and Funding Techniques Involved in the Shadow Banking Activities of European Banks

	Function	Shadow Banks	Shadow Banks' Funding*
Step (1)	Loan Origination	-	-
Step (2)	Loan Warehousing	Multi-seller conduits	ABCP
Step (3)	ABS Issuance	-	-
Step (4)	ABS Warehousing	Hybrid and TRS/repo conduits	ABCP
Step (5)	ABS CDO Issuance	-	-
Step (6)	ABS Intermediation	Securities arbitrage conduits and SIVs	ABCP, MTN and capital notes
Step (7)	Wholesale Funding	-	-

*Funding types highlighted in red denote securitized funding techniques. Securitized funding techniques are *not* synonymous with secured funding.

Source: Shadow Banking (Pozsar, Adrian, Ashcraft, Boesky (2010))

The European banks’ involvement in shadow banking was dominated by German Landesbanks (and their off-balance sheet shadow banks—securities arbitrage conduits and SIVs), although banks from all major European economies and Japan were active investors. The prominence of European banks as high-grade structured credit investors goes to the incentives that their capital charge regime (Basel II) introduced for holding AAA ABS, and especially AAA ABS CDOs. As major investors of term structured credits “manufactured” in the U.S., European banks, and their shadow bank offshoots

¹⁷ To be more precise, many European banks were also involved in the origination, warehousing and processing of loans through their U.S. commercial bank and broker-dealer subsidiaries (RBS and ABN Amro, for example). We already discussed these *diversified* European banks and their U.S. activities in the section describing FHCs. In this section, we intend to focus on less global, *undiversified* European banks that were relatively underexposed to U.S. credit.

Exhibit 11: The European Banks-Based ABS Intermediation Process

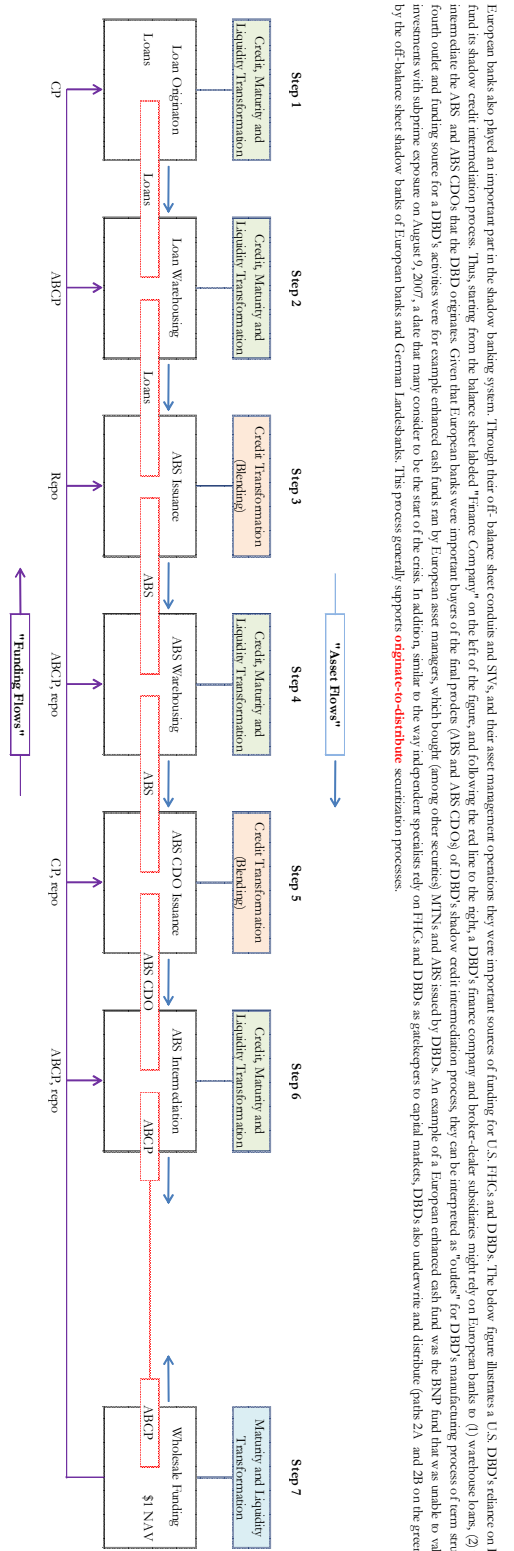

European banks also played an important part in the shadow banking system. Through their off-balance sheet conduits and SPVs, and their asset management operations they were important sources of funding for U.S. FHCS and DBDs. The below figure illustrates a U.S. DBD's reliance on European institutions to fund its shadow credit intermediation process. Thus, starting from the balance sheet labeled "Finance Company" on the left of the figure, and following the red line to the right, a DBD's finance company and broker-dealer subsidiaries might rely on European banks to (1) warehouse loans, (2) warehouse ABS and (3) intermedicate the ABS and ABS CDOs that the DBD originates. Given that European banks were important buyers of the final products (ABS and ABS CDOs) of DBD's shadow credit intermediation process, they can be interpreted as "outlets" for DBD's manufacturing process of firm structured credit assets. A fourth outlet and funding source for a DBD's activities were for example enhanced cash funds run by European asset managers, which bought (among other securities) MTNs and ABS issued by DBDs. An example of a European enhanced cash fund was the BNP fund that was unable to value its money market investments with surprise exposure on August 9, 2007, a date that many consider to be the start of the crisis. In addition, similar to the way independent specialists rely on FHCS and DBDs as gatekeepers to capital markets, DBDs also underwrite and distribute (paths 2A and 2B on the green line) the liabilities issued by the off-balance sheet banks of European banks and German Landesbanks. The process generally supports **originate-to-distribute** securitization processes.

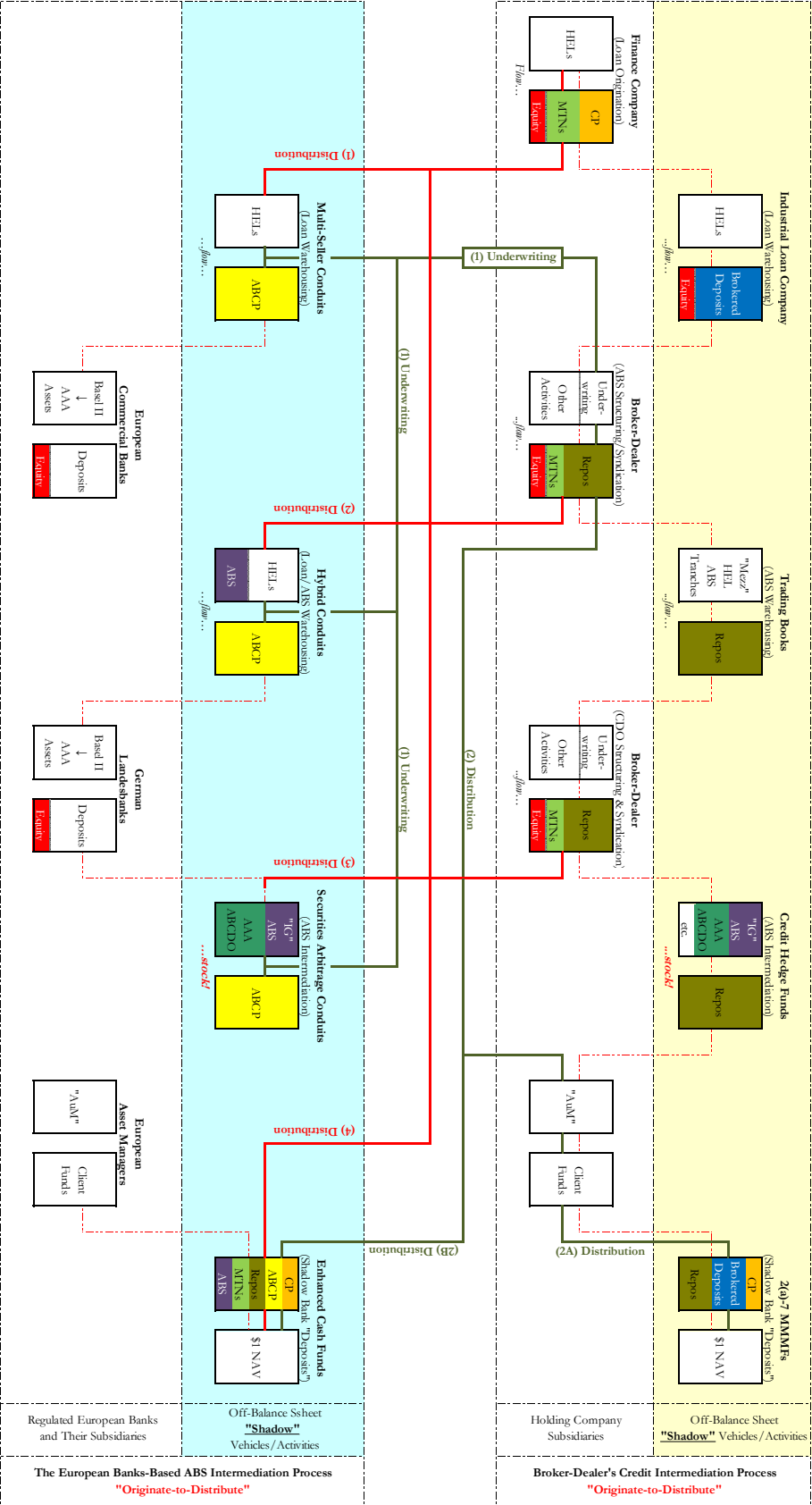

were an important part of the “funding infrastructure” that financed the U.S. current account deficit (see Exhibit 11).¹⁸

Similar to FHCs’ credit intermediation process, the maturity and credit transformation performed through European banks’ ABS intermediation activities were not adequately backstopped:

First, while European banks had access to the ECB for funding, they only had access to euro funding, and not dollar funding. However, given that ABS intermediation involved mainly U.S. dollar-denominated assets, a euro-based lender of last resort was only a part of a solution of funding problems, as borrowed euro funds had to be swapped into dollars, which in turn needed willing counterparties and a liquid FX swap market at all times. As the crisis has shown, however, FX swap markets can become illiquid and dysfunctional in times of systemic stress.

Second, similar to other shadow banks, the liabilities of European banks’ shadow banking activities were not insured explicitly, only implicitly: some liabilities issued by European shadow banks—namely, German Landesbanks-affiliated SIVs and securities arbitrage conduits—benefited from the implicit guarantee of German federal states’ insurance.¹⁹ European banks’ and other banks’ and non-banks’ involvement in ABCP funded shadow credit intermediation activities is listed in Exhibit 12.

¹⁸ Other parts of the shadow banking system that were instrumental in funding the U.S. current account deficit include (1) limited purpose finance companies and SIVs, which invested significant amounts of foreign (non-U.S.) capital in ABS backed by loans originated in the U.S., and (2) foreign central banks’ holdings of U.S. Treasuries and Agency debt and MBS, which were often lent by their custodian banks to short-sellers; the cash collateral received in exchange for the securities lent were in turn reinvested in ABS backed by loans originated in the U.S.

¹⁹ In part, this implicit guarantee was the reason why liabilities issued by Landesbanks’ shadow banks could get top credit ratings for their liabilities from the ratings agencies.

Exhibit 12: ABCP Issuers' "Location-Type-Vehicle" Matrix
 ABCP outstanding as of June 30, 2007, millions

U.S. Sponsor Type	USD	EUR	European Sponsor Type	USD	EUR	Landesbanks	USD	EUR
U.S. Commercial Banks <i>(Including the New York branches of non-U.S. banks)</i>			European Commercial Banks <i>(Including the London branches of U.S. banks)</i>			German Landesbanks		
Multi-seller conduits	278,134	10,420	Securities arbitrage conduits	106,108	50,060	Hybrid conduits	37,023	33,090
Hybrid conduits	34,578	-	Hybrid conduits	91,983	53,072	Securities arbitrage conduits	20,998	11,397
Single-seller conduits	24,757	-	SIVs	32,176	23,286	SIVs	7,174	1,960
Securities arbitrage conduits	17,178	-	Multi-seller conduits	22,561	37,255			
			Single-seller conduits	1,075	8,083			
Total	354,647	10,420	Total	252,828	163,672	Total	65,195	46,447
U.S. Independent Sponsors			European Independent Sponsors					
Hybrid conduits	51,057	92	SIVs	4,034	512			
Multi-seller conduits	42,750	-						
SIVs	6,722	1,031						
Securities arbitrage conduits	1,684	-						
Total	102,213	1,123	Total	4,034	512			
U.S. Finance Companies								
Single-seller conduits	63,836	-						
Multi-seller conduits	5,754	-						
Total	69,590	0						
U.S. REITs								
Securities arbitrage conduits	19,994	-						
Single-seller conduits	184	-						
Total	20,178	0						
U.S. Insurers								
Securities arbitrage conduits	6,214	2,128						
SIVs	2,708	-						
Multi-seller conduits	720	-						
Total	9,642	2,128						
U.S. Industrial Loan Companies (ILCs)								
Securities arbitrage conduits	4,986	-						
Multi-seller conduits	1,643	-						
Total	6,629	0						
U.S. Broker-Dealers								
Securities arbitrage conduits	3,491	-						
Single-seller conduits	850	-						
Total	4,341	0						
U.S. Nonfinancials			European Nonfinancials					
Single-seller conduits	2,461	-	Single-seller conduits	2,000	-			
Total	2,461	0	Total	2,000	0			
U.S. Pension Funds								
SIVs	919	-						
Total	919	0						
Grand Total	570,621	13,671	Grand Total	258,862	164,184	Grand Total	65,195	46,447

Source: Shadow Banking (Pozsar, Adrian, Ashcraft, Boesky (2010)), Moody's

I.4.3 The "External" Shadow Banking Sub-System

The mixture of bank and markets-based credit intermediation process that emerged from within FHCs and was also practiced by some European banks was later adopted by diversified broker dealers (DBDs)²⁰ and also turned a range of independent, specialist non-banks into an

²⁰ Diversified broker-dealers are sometimes referred to as investment bank holding companies.

interconnected network of financial entities that operated completely external to banks and the official safety net extended to banks—hence the term “external” shadow banking sub-system.

Similar to the “internal” shadow banking sub-system, the “external” shadow banking sub-system was a global network of balance sheets, with the origination, warehousing and securitization of loans conducted mainly from the U.S., and the funding and maturity transformation of structured credit assets conducted mainly from the U.K., Europe and various offshore financial centers.²¹ However, unlike the “internal” sub-system, the “external” sub-system was less of a product of regulatory arbitrage, and more a product of vertical integration and gains from specialization.

The “external” shadow banking sub-system is defined by (1) the credit intermediation process of diversified broker-dealers; (2) the credit intermediation process of independent, non-bank specialist intermediaries; and (3) the credit puts provided by private credit risk repositories.

I.4.3.1 The Credit Intermediation Process of Diversified Broker-Dealers

Large, complex, diversified broker-dealers (DBD), which, in their efforts to vertically integrate their securitization businesses (from origination to funding) acquired lending platforms (finance companies) and asset management units over the past decades, effectively copied the market-based lending model that emerged from within FHCs. However, in the absence of limits on their leverage, DBDs—the pre-crisis group of the five broker-dealers (Bear Stearns, Goldman Sachs, Lehman Brothers, Merrill Lynch and Morgan Stanley)—conducted these activities at much higher multiples

²¹ U.K. and European lenders were also “plugged” into the shadow banking system. From their perspectives, the process was exactly the opposite, with the origination and processing of loans (typically pound and euro denominated) conducted from Europe. Beyond tranching, the processing of loans also involved a currency swap, turning the pound and euro cash flows generated by the loan pool behind a securitization into dollars, which were paid out by the tranches of the securitization. The short-dated, dollar-denominated tranches of these deals were often purchased by 2(a)-7 money market mutual funds in the United States.

of leverage than FHCs. The credit intermediation process of DBDs is similar to those of FHCs, with only four differences (see Exhibit 13):

Exhibit 13: The Steps, Entities and Funding Techniques Involved in DBDs' Credit Intermediation Process

	Function	Shadow Banks	Shadow Banks' Funding*
Step (1)	Loan Origination	Finance company subsidiary	CP, MTNs, bonds
Step (2)	Loan Warehousing	Independent multi-seller conduits	ABCP
Step (3)	ABS Issuance	SPVs, structured by broker-dealer subsidiary	ABS
Step (4)	ABS Warehousing	Hybrid, TRS/repo conduits, broker-dealers' trading books	ABCP, repo
Step (5)	ABS CDO Issuance	SPVs, structured by broker-dealer subsidiary	ABS CDOs, CDO-squareds
Step (6)	ABS Intermediation	Internal credit hedge funds, proprietary trading desks	Repo
Step (7)	Wholesale Funding	2(a)-7 MMMFs, enhanced cash funds, securities lending subs.	\$1 NAV shares (shadow bank "deposits")

*Funding types highlighted in red denote securitized funding techniques. Securitized funding techniques are *not* synonymous with secured funding.

Source: Shadow Banking (Pozsar, Adrian, Ashcraft, Boesky (2010))

First, since broker-dealers did not have commercial bank subsidiaries, they originated loans from their industrial loan company (ILC) and federal savings bank (FSB) subsidiaries, and in turn, from their ILCs' and FSBs' finance company subsidiaries. ILCs and FSBs were the only forms of depository institutions (traditional banks) that DBDs could own without becoming FHCs.

Second, since running one's own loan warehouses (single- or multi-seller loan conduits) required large bank subsidiaries to fund the contingent liquidity backstops that enhanced the ABCP issued by the conduits, broker-dealers typically outsourced these warehousing functions to FHCs and European banks with large deposit bases, or to independent multi-seller, hybrid or TRS conduits.

Third, at the end of their intermediation chains, DBDs did not have securities arbitrage conduits and SIVs, but instead internal credit hedge funds, trading books and repo conduits. Partly due to this reason, DBDs' intermediation process was more reliant on repo funding than that of FHCs', which relied on a relatively even mix of CP, ABCP, MTNs as well as repos. Broker-dealers' prominent reliance on repo was also due to their usage of their trading books (instead of conduits) to fund loan pools and structured credit assets and their securitization pipelines of ABS and ABS CDOs.

Fourth, and finally, the types of credit intermediated by diversified broker-dealers were similar to FHCs, with the exception that they did not originate credit card loans (which were the near-exclusive domain of FHCs) and were less prominent lenders of conforming mortgages, FFELP student loans and SBA loans. Diversified broker-dealers were particularly important originators of subprime and non-conforming mortgages, commercial mortgages and leveraged loans.

Similar to FHCs' intermediation process, where only the bank subsidiary had access to the discount window, the only DBD subsidiaries that were backstopped by the Federal Reserve and the FDIC were their ILC and FSB subsidiaries (at least until the introduction of the Primary Dealer Credit Facility in March 16, 2008), but not the numerous other subsidiaries that were involved in the origination, processing and movement of loans and structured credits as they passed through DBDs' credit intermediation process. Similar to FHCs' commercial banks, DBDs' ILC and FSB subsidiaries were restricted in terms of the amount of funds and discount window liquidity they could "upstream" to the holding company for use by other subsidiaries.

To remind the reader, the credit intermediation processes described above are the simplest and shortest forms of the intermediation chains that run through FHCs and DBDs. In practice, these processes were often elongated by additional steps involved in the warehousing, processing and distribution of unsold/unsellable ABS into ABS CDOs (see Exhibit 14).

Exhibit 14: The Credit Intermediation Process of Diversified Broker Dealers

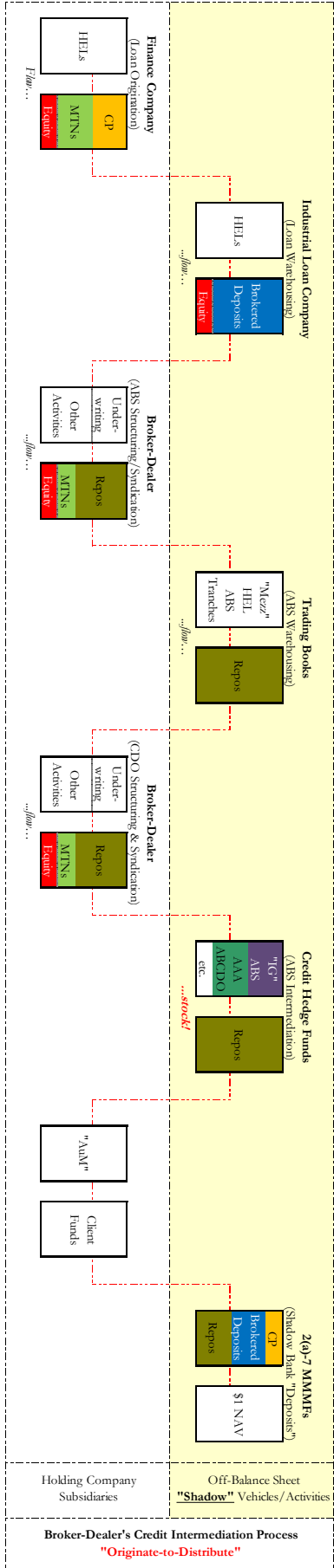
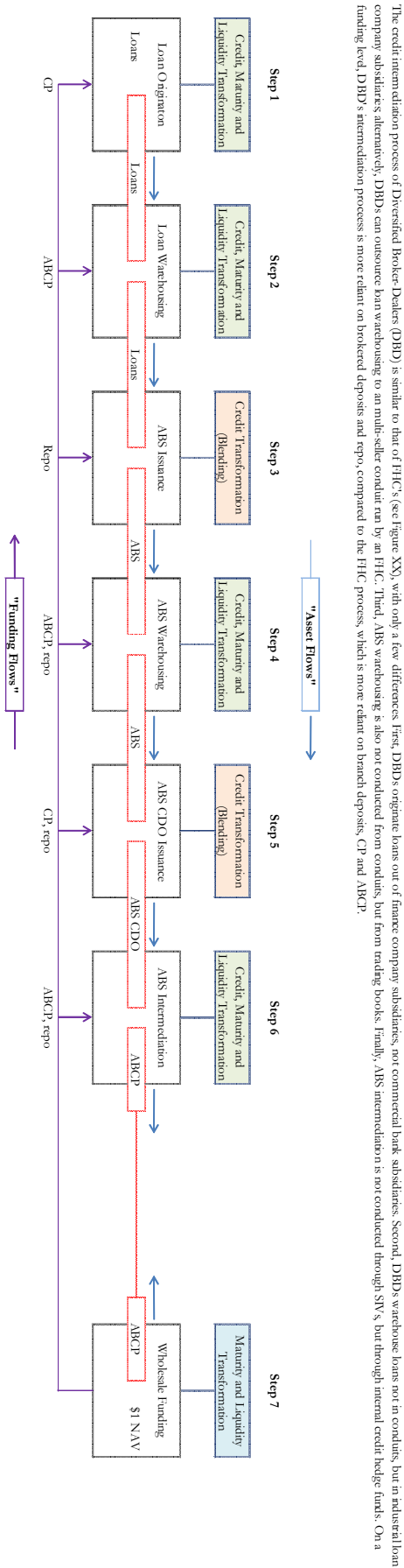

Source: Shadow Banking (Pozsar, Adam, Askeralf, Boesky (2010))

I.4.3.2 The Independent Specialists-Based Credit Intermediation Process

The credit intermediation process that runs through a network of independent, specialist non-bank financial intermediaries performed the very same credit intermediation functions as those performed by traditional banks or the credit intermediation process of FHCs and DBDs.

The independent specialists-based intermediation process includes the following types of entities: stand-alone and captive finance companies on the loan origination side²²; independent multi-seller conduits on the loan warehousing side; and limited purpose finance companies (LPFCs), independent SIVs and credit hedge funds on the ABS intermediation side (see Exhibit 15).

Exhibit 15: The Steps, Entities and Funding Techniques Involved in the Independent Specialists-Based Credit Intermediation Process

	Function	Shadow Banks	Shadow Banks' Funding*
Step (1)	Loan Origination	Standalone and captive finance companies	CP, MTNs and bonds
Step (2)	Loan Warehousing	FHC-sponsored and independent multi-seller conduits	ABCP
Step (3)	ABS Issuance	SPVs, structured by broker-dealers	ABS
Step (4)	ABS Warehousing	-	ABCP, repo
Step (5)	ABS CDO Issuance	-	ABS CDOs, CDO-squareds
Step (6)	ABS Intermediation	LPFCs, independent SIVs, independent credit hedge funds	ABCP, MTN, capital notes and repo
Step (7)	Wholesale Funding	2(a)-7 MMMFs, enhanced cash funds, securities lenders.	\$1 NAV shares (shadow bank "deposits")

*Funding types highlighted in red denote securitized funding techniques. Securitized funding techniques are *not* synonymous with secured funding.

Source: Shadow Banking (Pozsar, Adrian, Ashcraft, Boesky (2010))

There were three key differences between the independent specialists-based credit intermediation process and those of FHCs and DBDs (see Exhibit 16):

First, and foremost, on the origination side, these three processes intermediate different types of credit. The FHC and DBD-based processes originate some combination of both conforming and

²² Captive finance companies are finance companies that are owned by non-financial corporations. Captive finance companies are typically affiliated with manufacturing companies, but might also be affiliated with homebuilders as well, for example. Captive finance companies are used to provide vendor financing services for their manufacturing parents' wares. Some captive finance companies are unique in that they do not finance solely the sale of their parent's wares, but instead a wide-range of loan types, many of which are hard, or impossible for banks to be active in. Captive finance companies often benefit from the highly-rated nature of their parents, which gives them access to unsecured funding at competitive terms. Stand alone finance companies, as the name suggests stand on their own and are not subsidiaries of any other corporate entity.

non-conforming mortgages, as well as commercial mortgages, leveraged loans and credit card loans. In contrast, the independent specialists-based process tended to specialize in the origination of auto and equipment loans and leases, middle-market loans, franchise loans and more esoteric loans in which traditional banks and FHCs became less and less active over time. The obvious exceptions to this are standalone non-conforming mortgage finance companies, which are largely extinct today.²³

Second, the independent specialists-based credit intermediation process was based on an “originate-to-fund” (again, with the exception of the now extinct standalone mortgage finance companies) as opposed to the mostly “originate-to-distribute” model of the government-sponsored shadow banking sub-system and the credit intermediation process of FHCs and DBDs.

Third, while the GSE, FHC and DBD-based credit intermediation processes were heavily dependent on liquid capital markets for their ability to fund, securitize and distribute their loans, independent specialists’ seamless functioning was also exposed to DBDs’ and FHCs’ abilities to perform their functions as gatekeepers to capital markets and lenders of last resort, respectively. This in turn represented an extra layer of fragility in the structure of the independent specialists-based credit intermediation process, as failure by FHCs and DBDs to perform these functions in times of systemic stress ran the risk of paralyzing and disabling the independent specialists-based intermediation process (see Rajan (2005)). Indeed, this fragility became apparent during the financial crisis of 2007-2009 as the independent specialists-based process broke down, and with it the flow of corresponding types of credit to the real economy.

²³ It is fair to say that the independent specialists-based credit intermediation process became collateral damage in the collapse of standalone subprime mortgage originators and subprime securitizations.

Exhibit 16: Independent Specialists-Based Credit Intermediation Process - Specialists' Reliance on FHCs and DBDs as Gatekeepers to Capital Markets

The independent specialists-based credit intermediation process consists of entities like independent and captive finance companies on the loan origination side, limited purpose finance companies (LPFCs) and stand-alone SIVs and credit hedge funds on the ABS intermediation side, and LGIPs and non-bank affiliated MMFIs on the funding side. The independent specialists-based credit intermediation process is highly dependent on FHCs and DBDs as gatekeepers to capital markets and as underwriters of their securitization-based credit intermediation process. For example, starting from the bottom left balance sheet ("Captive Standalone Finance Company") and going to the right along the red line, finance companies rely on (1) FHC-affiliated multi-seller conduits for loan warehousing, (2) broker-dealers for the structuring and syndication of the ABS that funds their retained loans, which by definition are **originate-to-fund** securitizations (in contrast to FHCs and DBDs originate-to-distribute securitizations), (3) broker-dealers for the distribution of ABS to LPFCs (path 3A) and alternatively to SIVs (path 3B) that are affiliated with the FHC that owns the broker-dealer. Additionally, along the green line that begins from the balance sheet labeled "LPFCs", LPFCs rely on broker-dealers to underwrite their CP (as well as MTNs and capital notes) and (2) distribute them to FHC/DBD-affiliated MMFIs and LGIPs (paths 2A and 2B, respectively), as well as real money accounts, which are not depicted. Also note that the below figure do not depict the entire FHC process from Figure XX, only those parts of it that are relevant to the credit intermediation process of independent specialists.

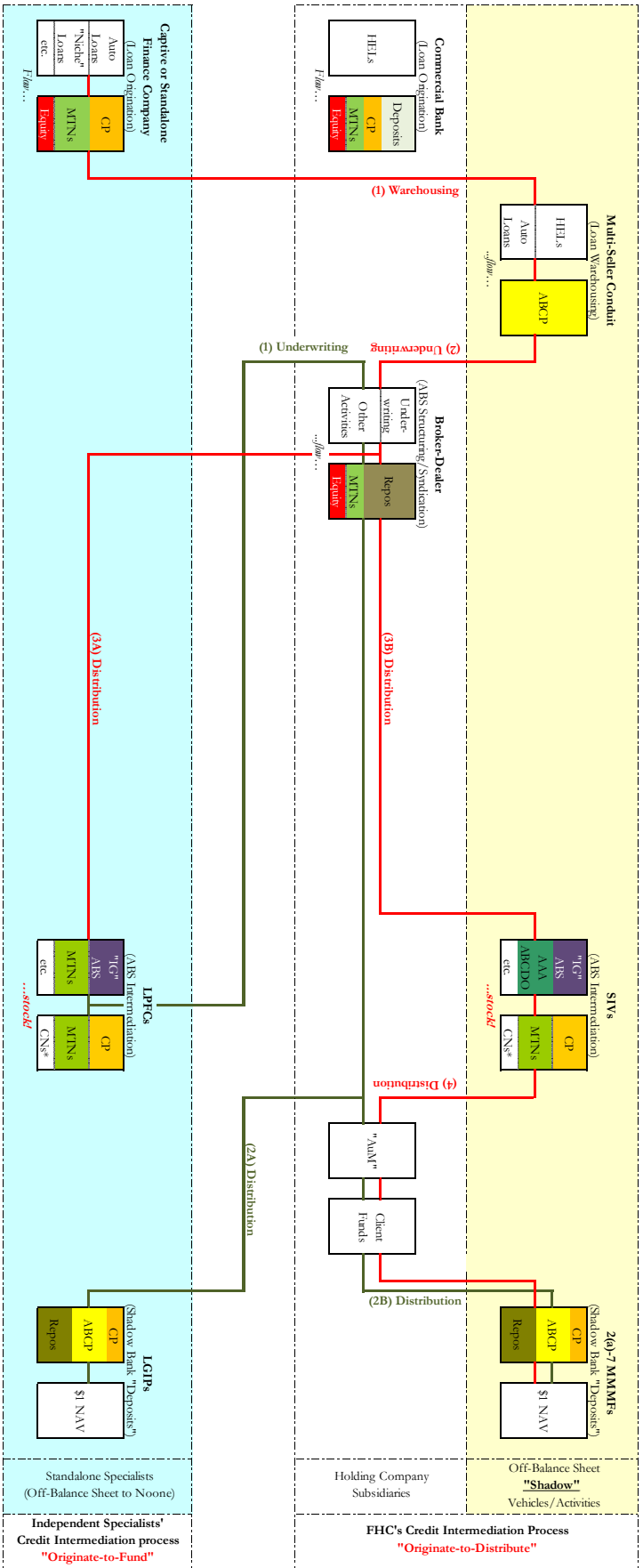
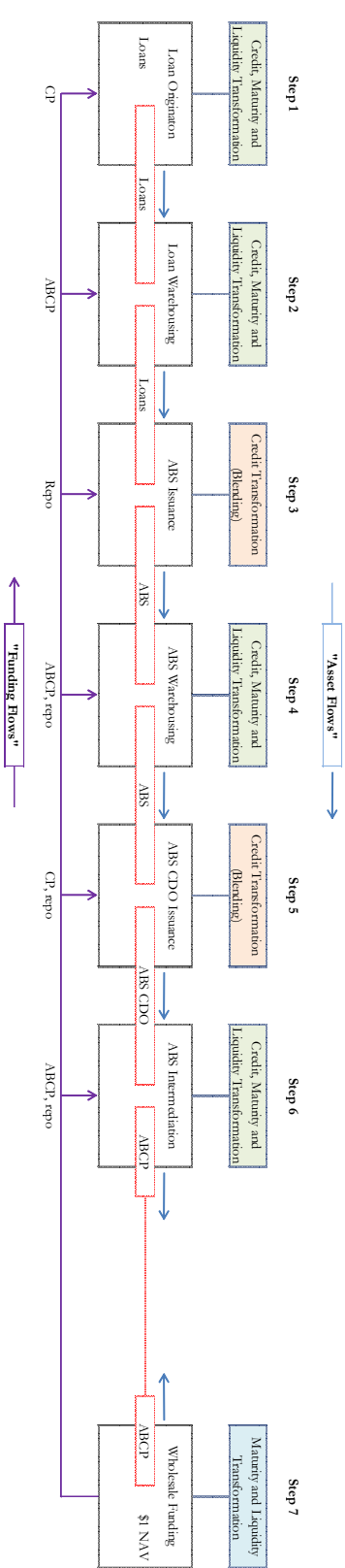

Source: Shadow Banking (Prosser, Adria, Asterici, Bessy (2010))

Exhibit 17 shows the relative extent to which specialist loan originators (captive and independent finance companies) relied on FHCs and DBDs as their ABS underwriters and gatekeepers to capital markets.

Exhibit 17: Top Bookrunners of U.S. ABS in 2007

Issuance on Behalf of "External" Clients			Issuance on Behalf of "Internal" Clients		
Broker-Dealers (Bookrunners)	Issuance Volume	Deal Count	Broker-Dealers (Bookrunners)	Issuance Volume	Deal Count
	<i>\$ millions</i>	#		<i>\$ millions</i>	#
Greenwich Capital Markets Inc.	49,068	113	JP Morgan	26,989	37
Citigroup Global Markets, Inc.	47,916	101	Citigroup	23,631	25
Lehman Brothers	44,774	89	Banc of America Securities LLC	18,825	25
Deutsche Bank	37,608	99	Countrywide Securities Corp	17,416	20
JP Morgan	34,500	73	Lehman Brothers	7,458	18
Merrill Lynch	33,900	54	Goldman Sachs & Co	5,306	11
Morgan Stanley	31,321	56	Morgan Stanley	4,453	5
Banc of America Securities LLC	29,953	93	HSBC Securities Inc	2,709	4
Credit Suisse	29,869	82	Merrill Lynch	2,647	4
Barclays Capital	28,793	61	Wachovia Securities Inc	2,595	2
Bear Stearns & Co Inc	20,345	51	Barclays Capital	1,813	5
Wachovia	18,615	35	Deutsche Bank Securities Corp	1,503	3
UBS Investment Bank	15,892	39	Greenwich Capital Markets Inc	847	2
HSCB Securities Inc.	13,262	19	Credit Suisse	304	2
Countrywide Securities Corp	12,139	27	National City Bank(Cleveland)	124	1
Goldman Sachs & Co	10,883	42			
Royal Bank of Scotland	9,459	11			
ABN AMRO Incorporated	3,456	7			
WaMu Capital Corp.	3,446	10			
RBC Capital Markets	3,047	6			
BNP Paribas SA	1,972	7			
GMAC-RFC Health Capital	1,729	5			
Total	481,947	1,080	Total	116,618	164

Source: JPMorgan, authors

I.4.3.3 Private Credit Risk Repositories

While the credit intermediation process of independent specialists was highly reliant on FHCs and DBDs for gatekeeper and lender of last resort functions, FHCs and DBDs in turn were highly

reliant on private credit risk repositories of the “external” shadow banking sub-system in their abilities to perform originate-to-distribute securitizations (see Exhibit 18).²⁴

Private risk repositories specialized in providing credit transformation services in the shadow banking system, and included mortgage insurers, monoline insurers, certain subsidiaries of large, diversified insurance companies, credit hedge funds and credit derivative product companies. These entities, as investors in the junior equity and mezzanine tranches of loan pools, all provided risk capital to the shadow banking system, thereby supporting credit extension to the real economy.

Different credit risk repositories correspond to specific stages of the shadow credit intermediation process. As such, mortgage insurers specialized in insuring, or wrapping whole mortgage loans; monoline insurers specialized in wrapping ABS tranches (or the loans backing a specific ABS tranches); and large, diversified insurance companies, credit hedge funds and credit derivative product companies specialized in taking on the risks of ABS CDO tranches through CDS.²⁵ There were also overlaps, with some monolines wrapping both ABS and ABS CDOs, for example.

Effectively, the various forms of credit put options provided by private risk repositories absorbed the tail risk out of the loan pools that were processed through the shadow banking system, turning the securities that were enhanced by them into credit-risk free securities (at least as far as investors’

²⁴ This is one example to highlight how the “internal” and “external” shadow banking sub-systems became symbiotic over time. Other examples include European banks’ ABS warehousing and intermediation activities, which enabled many U.S. FHCs and DBDs to “cleanse” their securitization pipelines, by moving credit exposures (loans, ABS and ABS CDOs) off their own books to European banks across the Atlantic. Often times, the very same broker-dealers who sold these securities to European banks also advised these banks on how to set up shadow banks (SIVs and securities arbitrage conduits) and provided gatekeeper functions to capital markets for these shadow banks.

²⁵ CDS were also used for hedging warehouse and counterparty exposures. For example a broker-dealer with a large exposure to subprime MBS that it warehoused for an ABS CDO deal in the making could purchase CDS protection on its MBS warehouse. In turn, the broker-dealer could also purchase protection (a counterparty hedge) from a credit hedge fund or CDPC on the counterparty providing the CDS protection on subprime MBS.

Exhibit 18. Independent Specialists-Based Credit Intermediation Process - FHCs and DBDs: Reliance on Independent Specialists

The "internal" and "external" shadow banking sub-systems are symbiotic. Not only is the independent specialists-based credit intermediation process dependent on FHCs and DBDs as warehouse providers and gatekeepers to capital markets, but FHCs and DBDs also relied on members of the "external" shadow banking system for funding and other functions. As such, independent specialists like LPTCs and securities lenders, for example, are instrumental in funding commercial banks and broker-dealers by buying their term debt. Furthermore, entities called private risk repositories were turning loan pools into AAA-rated, informationally insensitive securities, which in turn served as collateral in secured funding transactions. An example of such a transaction would be a repo collateralized by monoline-wrapped AAA-rated subprime RMBS, where a broker-dealer pledges the RMBS collateral for an overnight cash loan from a 2(a)(7) MMMF. Credit risk repositories were present in both **originate-to-distribute** and **originate-to- fund** securitization chains, and each type of risk repository corresponded to specific stages of the shadow credit intermediation process. As such, mortgage insurers wrapped securitized mortgage pools, monoline insurers wrapped ABS (on either the loan pool or the tranche side of deals) while entities like AIG-Financial Products (as well as credit hedge funds, and German Landesbanks SVs and conduits (famously IKB's Rimeland) by investing in the infamous ABX/CUS 2007-AC1 deal) were selling CDS on ABS CDOs. Credit risk repositories made the originate-to-distribute process seem riskless and essentially played the role of private-sector versions of the HDC, in the system.

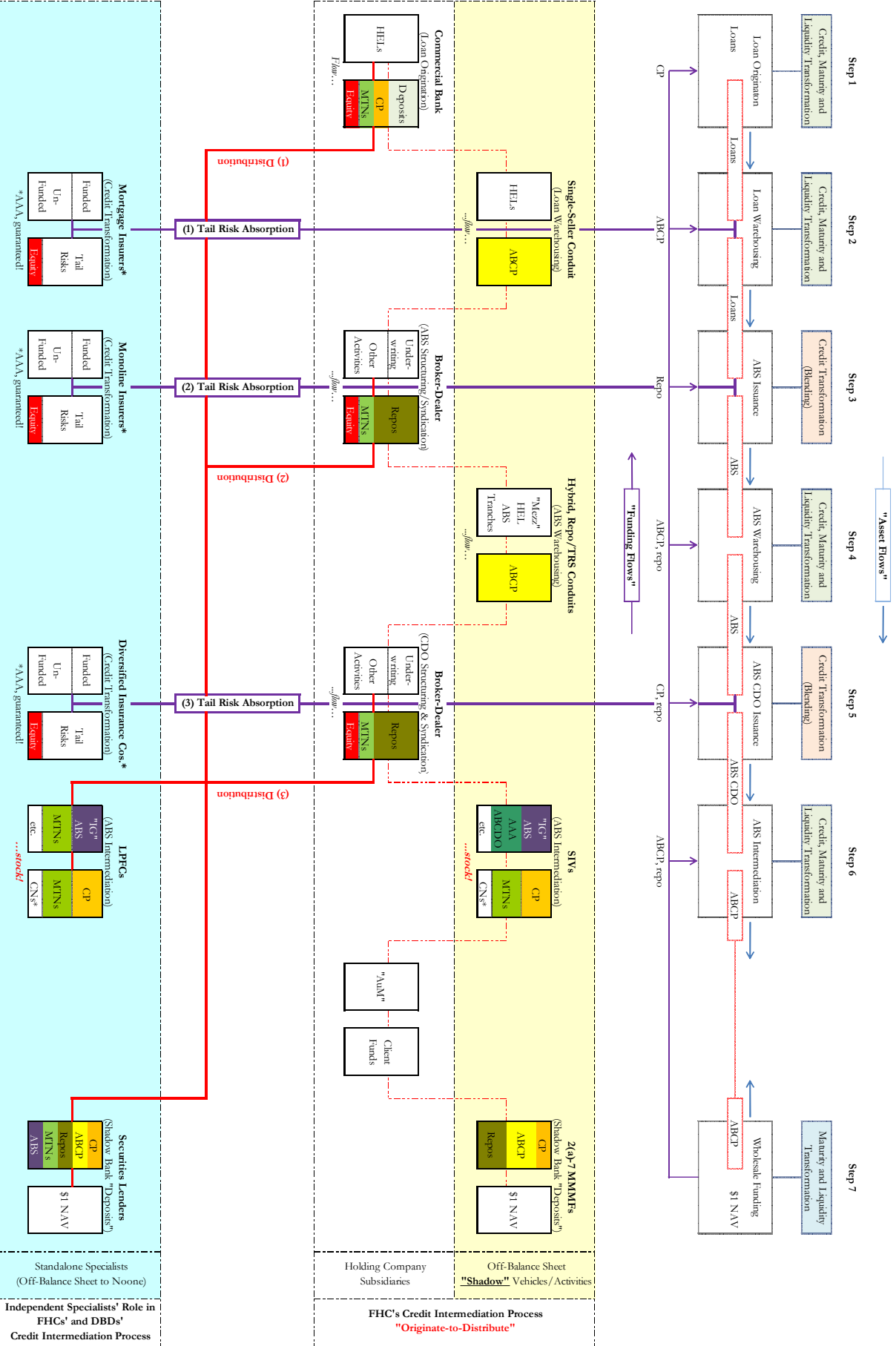

Source: Shadow Banking (Pozsar, Adria, Askeralf, Boesky (2010))

perception of them went). This in turn meant that any liability that was issued against these assets to fund them was perceived to be credit-risk free as well, as if it was FDIC-insured.

The perceived, credit-risk free nature of traditional banks' and shadow banks' liabilities stemmed from two very different sources. In the case of traditional banks' insured liabilities (deposits), the credit quality is driven by the counterparty—the U.S. taxpayer. As a result, insured depositors invest less effort into examining a bank's creditworthiness before depositing money than if they were uninsured (Gorton (2009)). In the case of shadow banks' liabilities (repo or ABCP, for example), perceived credit quality is driven by the “credit-risk free” nature of collateral that backs shadow bank liabilities, as it was often enhanced by private credit risk repositories. The AAA rating became the equivalent of “FDIC Insured” as a “brand” to express the credit-risk free nature of (insured) deposits in the traditional banking system.

The credit puts provided by private credit risk repositories were alternatives to the credit transformation performed by (1) the credit risk-based calibration of advance rates and attachment points on loan pools backing top-rated ABCP and ABS tranches, respectively; (2) the credit risk-based calibration of haircuts on collateral backing repo transactions; (3) the capital notes supporting LPFCs' and SIVs portfolios of assets, and (4) the pooling and re-packaging of non-AAA rated term ABS into ABS CDOs. The credit puts of private credit risk repositories were also similar in function to the wraps provided by Fannie Mae and Freddie Mac on conforming mortgage pools. Just as these government-sponsored, public credit risk repositories “borrowed” the AAA-rating of the federal government to pools of mortgage loans (turning them into credit risk-free rate products), the private credit risk repositories were effectively “borrowing” the AAA-rating of their parent.

1.4.4 The “Parallel” Banking System

Many “internal” and “external” shadow banks existed in a form that was possible only due to special circumstances in the run up to the financial crisis—some economic in nature and some due to regulatory and risk management failures. However, there were also many examples of shadow banks that existed due to gains from specialization and comparative advantage over traditional banks. We prefer to label the “long-term viable” set of shadow banks that were driven not by regulatory arbitrage, but by gains from specialization as the “parallel” banking system. Most (but not all) of the candidates for this system can be found in the “external” shadow banking sub-system.

These candidates could include non-bank finance companies, which are frequently more efficient than traditional banks through achieving economies of scale in the origination, servicing, structuring, trading and funding of loans to both bankable and non-bankable credits. For example, finance companies have traditionally served subprime credit card or auto loan customers, or low-rated corporate credits like the commercial airlines, which are not served by banks. Furthermore, some ABS intermediaries could fund highly-rated structured credit assets at lower cost and lower levels of leverage than banks with high RoE targets.

Over the last thirty years, market forces have pushed a number of activities outside of banks and into the parallel banking system. Interestingly, the reality of significant increases in traditional banks’ capital and liquidity requirements could make the “parallel” banking system even *more* prominent and competitive going forward. However, a related deep question is whether or not the “parallel” banking system will ever be stable through credit cycles in the absence of official credit and liquidity puts. If the answer is no, then there are questions about whether or not such puts and the associated prudential controls should be extended to parallel banks, or, alternatively, whether or not parallel banking activity should be severely restricted.

Policy discussions about the future of the “parallel” banking system should be done “parallel” to discussions about the range of activities which are appropriate *inside* the traditional banking system. For example, the recent financial reform legislation imposes restrictions on the proprietary trading activities of banks and directs banks to put swaps activity in to a non-bank subsidiary, but largely ignores credit intermediation activities that take place outside the traditional banking system. In the end, the principle that should connect each theme of the regulatory reform debate is the identification of all forms of activities that facilitate credit intermediation (whether they are conducted from inside or outside of banks) that should take place with the benefit of public-sector liquidity and credit enhancement, and what (if anything) should take place in the shadows.

I.5 FUNDING THE SHADOW BANKING SYSTEM

The traditional banking system relies on deposits gathered through bank branches for funding. The shadow banking system relies on the issuance of money market instruments (such as CP, ABCP and repo) to money market investors (such as money market mutual funds) for funding, as well as the issuance of longer-term medium-term notes (MTNs) and public bonds to medium- to longer-term debt investors such as securities lenders, pension funds and insurance companies.

The funding of any financial institution (banks, non-banks, the GSEs and shadow banks) through the sale of money market and longer-term debt instruments is called wholesale funding, and the instruments involved are called wholesale funding instruments

The wholesale funding market is a broad term that includes the bank-to-bank subset called the interbank market. In the interbank market, only banks lend to and borrow from each other. In the non-interbank wholesale funding market, banks as well as other non-bank financial institutions borrow from non-bank money market investors, such as money market mutual funds and similar

funds, institutional investors, corporate treasurers and state and local and foreign governments. By and large, wholesale funding refers to the funding of the shadow banking system.

I.5.1 The Borrowers of Wholesale Funds

The market for debt securities with a maturity of up to 13 months or less is generally referred to as the money market. The universe of money market borrowers can be divided into three groups. These are (1) non-financial borrowers, (2) agency (that is, GSE) borrowers and (3) financial borrowers (Exhibit 19).

The group of non-financial borrowers includes nonfinancial corporations that issue non-financial commercial paper; the U.S. Treasury, which issues Treasury bills; and state and local governments, which issue short-term municipal bonds. Non-financial borrowers' motivations to borrow in money markets on a short-term basis include, for example, bridging the cash-flow gap between paying suppliers and receiving cash from customers in the case of corporations; paying Social Security dues and federal tax receipts in the case of the federal government; and paying teachers and building schools, roads and dams and state and local tax receipts in the case of state and local governments.

The group of agency borrowers include the GSEs Fannie Mae, Freddie Mac and the FHLB system (or the government-sponsored shadow banking sub-system), which issue agency discount notes and benchmark and reference bills. The GSEs' motivations to borrow in money markets on a short-term basis include, for example, bridging the cash-flow gap between purchasing and securitizing mortgages and funding and managing the duration risks of their retained investment portfolios of private-label ABS and whole loans.

Exhibit 19: Money Market Borrowers and Their Respective Funding Instruments

Money Market Borrowers		
<u>Non-Financial Borrowers:</u>	<u>Agency (GSE) Borrowers:</u>	<u>Financial Borrowers:</u>
Non-Financial corporations	Fannie Mae	Commercial Banks
U.S. Treasury	Freddie Mac	Broker-Dealers
State and local governments	FHLBs	Shadow Banks
Money Market Instruments		
<u>Short-Term Bills/CP:</u>	<u>Short-Term Agencies:</u>	<u>Wholesale Funding Instruments:</u>
Non-financial CP	Discount notes	Financial CP, BDPs...
Treasury bills	Reference bills	...repos...
Short-term munis	Benchmark bills	...ABCP, ARS, TOB and VRDOs

Source: Shadow Banking (Pozsar, Adrian, Ashcraft, Boesky (2010))

The group of financial borrowers includes money center banks, broker-dealers and private (that is, non-GSE) shadow banks (see above). These borrowers, similar to the GSEs, look to money markets to obtain wholesale funding. Unlike the money market instruments issued by non-financial and agency borrowers, which are unsecured liabilities, the money market instruments issued by these financial borrowers are either unsecured or secured. Unsecured wholesale money market instruments include large brokered-deposits, Eurodollar deposits and commercial paper (CP). Secured wholesale funding sources include asset-backed commercial paper (ABCP), as well as ARSs, TOBs and VRDOs. While they are secured forms of funding, term ABS and ABS CDOs are not wholesale funding instruments, but rather maturity-matched, term funding structures for loans and ABS tranches, respectively. However, ABS and ABS CDOs serve as collateral in repo agreements, which were another major form of short-term secured funding technique in money markets.

Money center banks and broker-dealers typically “tap” into money markets for funding either through CP or repo, while shadow banks rely on all the above money market instruments for funding. These instruments facilitate and fund the shadow credit intermediation process. Money market investors that hold shadow banks’ liabilities are shadow banks’ “depositors” (see Exhibit 20).

Exhibit 20: Shadow Banks and Their "Depositors"

Shadow Banks			Shadow Bank "Depositors"		
Types	Assets	Liabilities	Assets	Types	Liabilities/Risks
Finance companies	Whole loans	CP, MTN ABCP ABCP, SLNs Brokered deposits ABCP, SLNs ABCP, SLNs Repo/Reverse Repo* CP, MTN CP, MTN CP, MTN ABCP, SLNs Repo/Reverse Repo* ARS TOB VRDO	<div style="border: 1px dashed red; padding: 2px;"> Regulated MMIs: Government only funds Prime funds Unregulated MMIs: Cash "plus" funds Enhanced cash funds Ultra-short bond funds Overnight sweeps Direct MM Investors: Corporate treasurers LGIPs Institutional investors Securities lenders </div>		
Multi-seller conduits	Whole loans			\$1 NAV	Reputational risks
Single-seller conduits	Whole loans			\$1 NAV	Reputational risks
Industrial loan companies	Whole loans				
Repo conduits	Whole loans, ABS				
Hybrid conduits	Whole loans, ABS				
Trading books	Whole loans, ABS				
LPFCs	Bank debt, ABS				
SIVs	Bank debt, ABS, CDOs				
SIV-Lites	ABS, CDOs				
Securities arbitrage conduits	ABS, CDOs				
Credit hedge funds	ABS, CDOs				
ARs	ABS, CDOs, Municipal bonds				
TOBs	Municipal bonds				
VRDOs	Municipal bonds				

*Shadow banks' repo liabilities are shadow bank "depositors" reverse repo assets.

Source: Shadow Banking (Pozsar, Adrian, Ashcraft, Boesky (2010))

Traditionally, money markets helped borrowers bridge short-term cash flow mismatches. Starting in the 1980s, however, the mix of assets shifted away from mainly short-term assets (such as trade receivables, credit card and dealer floorplan loans) whose funding involves only minimal maturity transformation, to more longer-term assets (such as 30-year, subprime mortgages), whose funding involves considerable amounts of maturity transformation.

The genesis of the change in the term of assets funded in money markets can be largely traced back to (1) the introduction of bank capital rules in the 1980s, which made bank balance sheets more expensive, and (2) the threat posed to banks as credit intermediaries by diversified broker-dealers through the latter's innovative use of *term* securitization techniques. To counter the threat from broker-dealers, banks turned to the development and use of *short-term* securitization techniques such as off-balance sheet ABCP conduits to maintain their share of business, which at the same time also helped them avoid capital requirements.²⁶ Through this competition, the average term of loans funded in money markets lengthened over time, and the volume of credit intermediated through

²⁶ As noted before, diversified broker-dealers rarely sponsored ABCP securitizations, as in the absence of deep deposit bases, they were not well positioned to provide liquidity backstops to ABCP conduits.

short-term securitizations grew to rival the volume credit intermediated through term securitizations. Ultimately, it was the embedded rollover risks inherent in funding long-term assets through short-term securitization sold into money markets that triggered the run on the shadow banking system.

I.5.2 The Providers of Wholesale Funding

Money market investors effectively fund every step and shadow bank in the shadow credit intermediation process—in essence, money market investors (or more precisely, money market investors’ purchases of shadow bank liabilities) are the lifeblood of the shadow banking system.²⁷

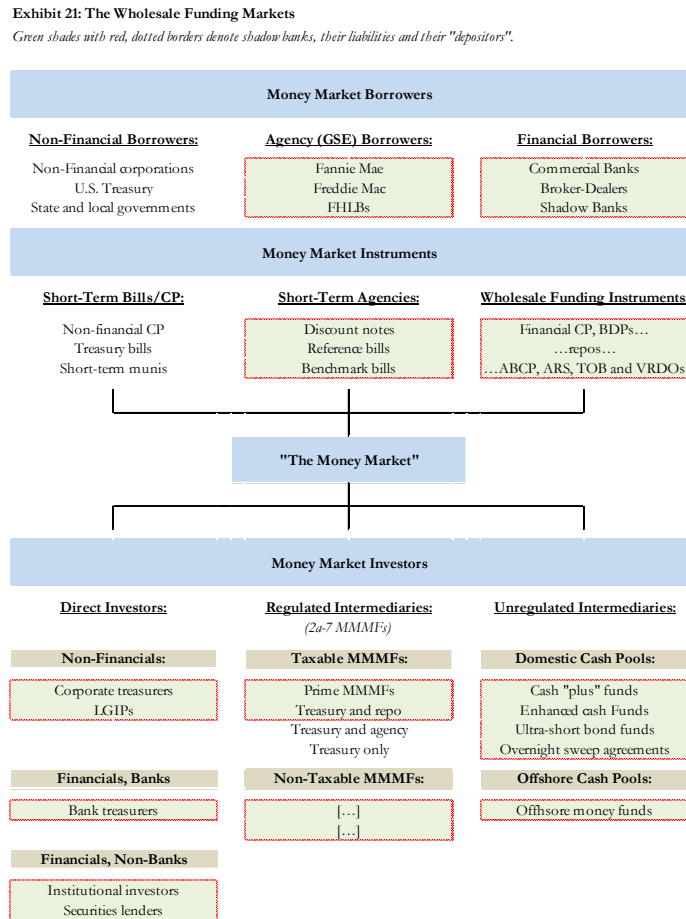

Source: Shadow Banking (Pozsar, Adrian, Ashcraft, Boesky (2010))

²⁷ In light of this comment, we need to talk about the new MMMF rules on the funding of the shadow banking system.

Similar to money market borrowers, the universe of money market investors can be subdivided into three sub-groups: (1) regulated money market intermediaries, (2) unregulated money market intermediaries and (3) direct money market investors (see Exhibit 21).

Money market intermediaries invest into money market instruments on behalf of households, corporations, governments and other institutions. Regulated money market intermediaries refer to 2(a)-7 money market mutual funds (MMMFs), and unregulated money market intermediaries refer to sweep accounts and cash “plus”, enhanced cash and ultra-short bond portfolios.

Direct money market investors invest in money market instruments directly, for their own accounts, and include local government investment pools (LGIPs) corporate treasurers, institutional investors, high net worth individuals and importantly, securities lenders’ cash collateral reinvestment accounts.

The geographic breakdown of the client base of money market intermediaries is interesting to highlight, as, for example, enhanced cash funds predominantly catered to foreign investors that had low tolerance for credit as well as duration risk in the recycling of dollars back to international capital markets. Such “no-credit, no duration” investors were one source of demand for the maturity and credit transformation that was conducted by the shadow banking system. In an interesting contrast to these investors, other foreign investors opted for no credit risk, but lots of duration risk through their investments in agency debt and agency MBS. The details of foreign investment strategies are crucial in understanding the macroeconomic implications of future “global savings gluts” (see Bernanke (2005)).²⁸ It also follows that enhanced cash funds were important parts of the funding infrastructure (together with European banks) within the shadow banking system that financed the U.S. current account deficit.

²⁸ <http://www.federalreserve.gov/boarddocs/speeches/2005/200503102/default.htm>

Exhibit 22: Money Market Mutual Funds by Type
as of June 30, 2007

Taxable MMMFs	AuM	WAL*	Tax Exempt MMMFs	AuM	WAL*	MMMF Complex
	<i>\$, thousand</i>	<i>days</i>		<i>\$, thousand</i>	<i>days</i>	
<u>Retail Class</u>			<u>Retail Class</u>			
Prime	831,883	50	Federal	135,486	23	
Government	121,507	36	State	91,114	27	
Treasury	106,657	20				
Total	1,060,047	45	Total	226,601	24	1,286,648
<u>Institutional Class</u>			<u>Institutional Class</u>			
Prime	717,608	44	Federal	124,575	21	
Government	98,804	31	State	34,388	28	
Treasury	86,997	26				
Total	903,408	41	Total	158,963	23	1,062,372
Grand Total	1,963,455			385,564		2,349,020

*WAL = weighted-average life (maturity transformation proxy)

Source: Crane Money Fund Intelligence, authors

On the eve of the financial crisis, the volume of cash under management by regulated and unregulated money market intermediaries and direct money market investors was \$2.5 trillion, \$1.5 trillion and over \$3 trillion, respectively (see Exhibits 22 and 23). This compares to bank deposits (as measured by the sum of checkable deposits, savings deposits and time deposits) of \$6.2 trillion.²⁹

These cash pools can effectively be interpreted as “shadow bank deposits”, as similar to banks’ deposits they were expected to be available on-demand and at par. In other words, these cash pools have an implicit “par” put option embedded in them. Yet, their promise of redemption at par and on-demand is not supported by any amount of capital or official enhancement whatsoever.

²⁹ Strikingly, regulatory reform efforts are completely ignoring cash intermediation activities outside of 2(a)-7 MMMFs.

Exhibit 23: Cash "Plus", Enhanced Cash and Ultra-Short Bond Funds
Assets under Management as of 06/30/2007, \$ billions

U.S. Incorporated Taxable		Offshore Incorporated Tax-Exempt		U.S. Incorporated Tax Exempt	
Cash "Plus" Funds		Cash "Plus" Funds		Cash "Plus" Funds	
Government	2.1	Euro	34.5	-	
Prime	190.7	Sterling	16.3	-	
		USD	20.0	-	
Total	192.8	Total	70.8	Total	3.6
Enhanced Cash Funds		Enhanced Cash Funds		Enhanced Cash Funds	
Government	0.3	Euro	26.6	-	
Prime	129.6	Sterling	10.6	-	
Prime + Sub-Investment Grade	39.3	USD	8.5	-	
Total	169.2	Total	45.7	Total	3.6
Ultra-Short Bond Funds		Ultra-Short Bond Funds		Ultra-Short Bond Funds	
Government	16.9	Euro	11.3	-	
Prime	123.9	Sterling	0.0	-	
Prime + Sub-Investment Grade	71.6	USD	2.5	-	
Total	212.4	Total	13.8	Total	12.0
Grand Total	574.4		130.3		19.2

Source: iMoneyNet

Note: Euro and sterling AuM estimates are USD equivalents.

I.5.3 The Continuum of Cash Management Strategies

Cash management strategies are best thought of along a continuum. On the conservative extreme are investments in insured deposits, followed by uninsured deposits and 2(a)-7 MMMFs. The latter can be further subdivided into Treasury-only, Treasury and Agency and repo and prime MMMFs in increasing order of riskiness.

Turning to unregulated money market intermediaries and direct money market investors, prime MMMFs are followed by sweep accounts and LGIPs on the risk/return spectrum of cash management styles, which in turn are followed by cash "plus", enhanced cash and ultra-short bond portfolios. The latter three funds are designed to provide slightly higher returns for investors than deposits and MMMFs, yet maintain nearly the same assurance of NAV stability (see Exhibit 24).

Exhibit 24: Cash Management Strategies on a Credit/Maturity Transformation Spectrum - Illustrative

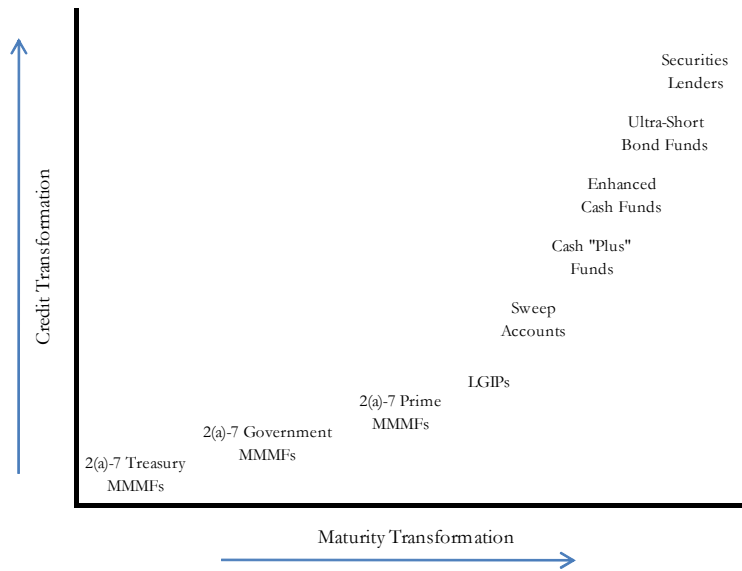

Source: Shadow Banking (Pozsar, Adrian, Ashcraft, Boesky (2010))

Higher returns were achieved through venturing further out on the maturity spectrum and further down on the credit spectrum than MMMFs. For example, enhanced cash funds often invested in the term, A2 tranches of ABS deals with maturities of as much as 2 years, or SIVs' medium-term notes, while MMMFs were restricted by rule 2(a)-7 to invest in only the A1, or money market tranche of ABS deals with maturities of up to 13 months, but not beyond.

Some (not all) securities lenders' cash collateral reinvestment accounts probably represent the most aggressive extreme of the continuum of cash management styles, as they invested heavily in longer-term term ABS tranches (and not only AAA tranches) and MTNs, and still promised \$1NAVs despite the far larger duration and credit risk they were taking compared to MMMFs.

Securities lenders' investments in floating-rate term ABS and MTNs in fact were so large that at the eve of the financial crisis, some market participants considered them to be *the* market for such securities (see Exhibit 25).

Exhibit 25: The Instrument Type Breakdown of Securities Lenders' Cash Reinvestment Accounts

	% of Reinvestment Portfolio		Change
	2007Q2	2009Q4	<i>ppts</i>
Fixed Rate Instruments			
Commercial Paper (ex. Asset Backed Paper) ¹	5.06%	9.28%	4.22
Asset Backed Securities	12.94%	3.49%	(9.45)
Funding Agreements	0.00%	0.03%	0.03
Other Corporates (ex. Repo Collateral)	0.28%	10.44%	10.16
Total	18.29%	23.24%	4.96
Floating Rate Instruments			
Commercial Paper (ex. Asset Backed Paper) ¹	0.65%	0.15%	(0.50)
Asset Backed Securities	13.43%	10.28%	(3.15)
Funding Agreements	2.43%	0.03%	(2.40)
Other Corporates (ex. Repo Collateral)	19.10%	17.38%	(1.73)
Total	35.61%	27.84%	(7.77)
Repurchase Agreements			
U.S. Treasuries	0.55%	1.82%	1.27
U.S. Government Agencies	10.42%	12.94%	2.52
Corporate Collateral			
<i>Investment Grade (A or Better)</i>	14.70%	6.12%	(8.58)
<i>Non-Investment Grade</i>	0.32%	2.90%	2.57
Equities	0.24%	3.10%	2.86
Whole Loans	0.25%	0.00%	(0.25)
Total	26.49%	26.87%	0.39
Bank Deposits			
Time Deposits	5.79%	4.41%	(1.38)
Certificates of Deposit	7.59%	8.16%	0.58
Other Bank Deposits	1.84%	0.34%	(1.51)
Total	15.22%	12.91%	(2.31)
Money Market Funds			
External Managed Funds [2(a)7]	1.21%	6.13%	4.93
External Managed Funds [Non-2(a)7]	0.51%	0.85%	0.33
Total	1.72%	6.98%	5.26
Other Vehicles ²	2.68%	2.16%	(0.52)
Grand Total	100%	100%	-

¹All asset backed paper is included in "Asset Backed Securities"

²Includes all other instruments that could not be categorized

Source: RMA

The continuum approach to describe cash management alternatives to insured bank deposits is a particularly appropriate approach to understanding and putting into context various shadow banks and the reasons for the run on the system. The activities and funding strategies of shadow banks

performing identical functions in the shadow credit intermediation process should all be evaluated along a continuum (see Exhibit 26).

Thus, not all shadow banking activities are inherently bad, and not all shadow banks were irresponsibly run. For example, in the area of loan origination (step 1 of the shadow credit intermediation process) finance companies could be excessively levered monoline lenders reliant on short-term funding, or they could be more conservatively levered diversified lenders that are reliant on an even mix of short, medium and long-term funding.

In the area of loan warehousing (step 2) a pair of examples would include bank-sponsored multi-seller conduits funding trade and short- to medium-term receivables, and single-seller conduits sponsored by standalone finance companies funding 30-year subprime mortgages with extendible ABCP and without a credit line from banks.

In the area of ABS issuance (step 3), term ABS might involve subprime home equity loans—representing the junior most slice of any homeowner’s balance sheet—that are particularly vulnerable to falling house prices, or prime auto loans, which are backed by depreciating assets in the first place. Another example might involve securitizations issued by master trusts with implicit recourse to the sponsor (representing only partial (or shadow) risk transfer) or securitizations issued by static pools representing a “true sale” of credit risk.

In the area of ABS intermediation (step 6), examples include ABS intermediaries investing in ABS could also be highly levered and reliant on overnight repo to fund an undiversified portfolio of low-quality subprime RMBS, or they could be levered reasonably and reliant on a geographically diverse, ABCP, MTNs, bonds and capital notes-based lending platform to fund a highly diverse portfolio of high-quality structured credit assets that span many debt and ABS types and geographies globally.

Figure 26: The Spectrum of Shadow Banks Within the Functions of Shadow Credit Intermediation - Illustrative Draft

Shadow banks are best thought along a spectrum. Each of the seven steps invoked in the shadow credit intermediation process were performed by many different types of shadow banks, with varying asset mixes, funding strategies, amounts of capital and degrees of leverage. The list of balance sheets below are an **illustrative** example of this. Thus, the shadow credit intermediation process was supported by various forms of equity of various degrees of strength (each denoted with a red call) as such, equity came in the form of common equity, overcollateralization (O/C), haircuts, equity tranches and capital notes. Wholesale funding providers (money market mutual funds, securities lenders) were the only actors involved in the shadow credit intermediation process without any form of capital supporting their activities. Having numerous types of shadow banks under each functional step of the shadow credit intermediation process means that each functional step can be performed many different ways. Depending on the asset mix and funding strategy employed, different shadow banks performing the same functions in the system conducted different amounts of credit, maturity and liquidity transformation. Shadow banks are listed vertically, top-down, in increasing order of riskiness.

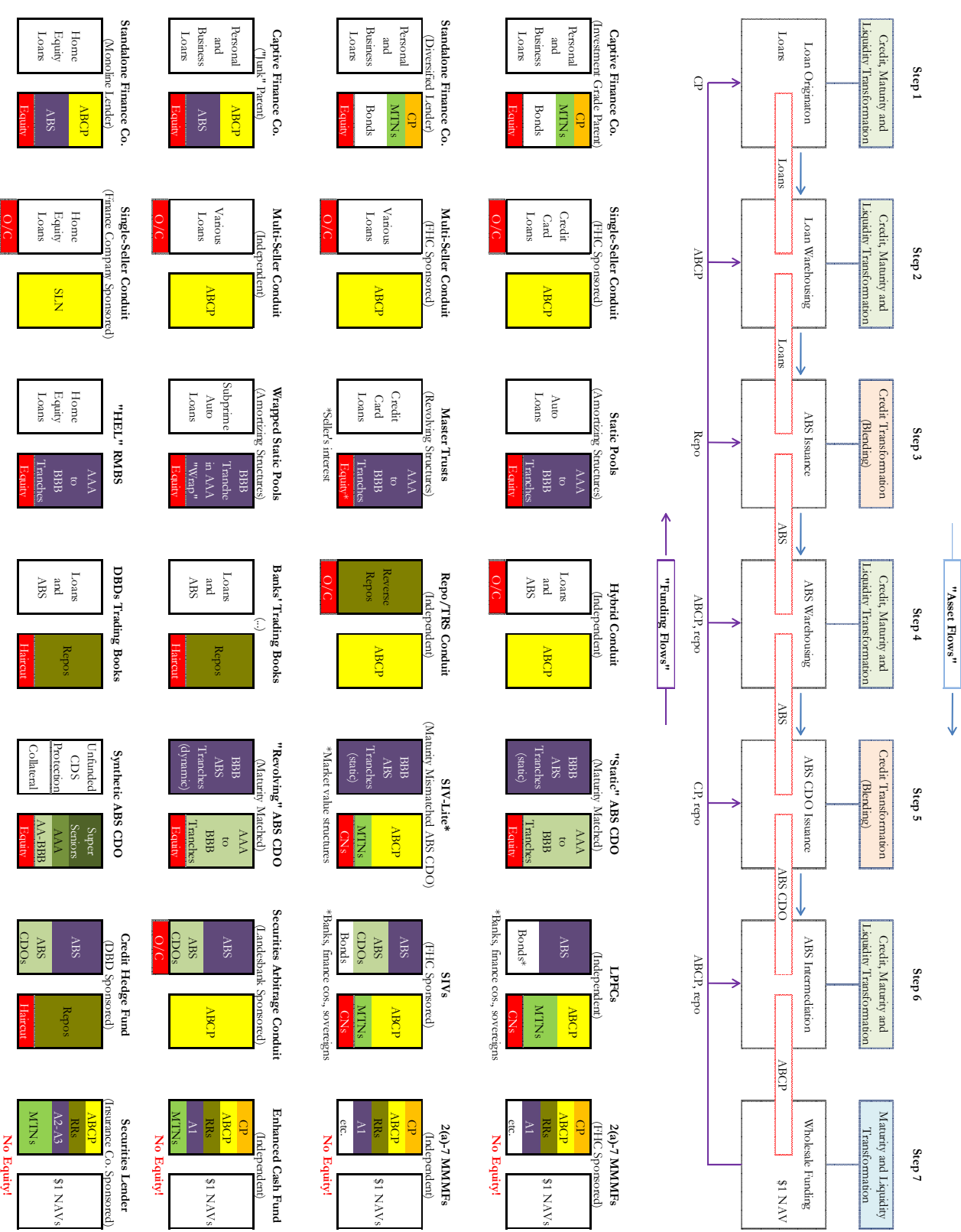

Source: Shadow Banking (Pozsar, Adra, Ashcraft, Boschy (2010))

Finally, in the area of wholesale funding (step 7), the primary motivation of a securities lender can be to lend securities to short sellers in order to capture certain securities' intrinsic values, or it could be to lend out the maximum number of securities in its portfolio (regardless of whether they have any intrinsic value to capture) with the motivation to maximize the volume of cash collateral in its reinvestment account and to invest that cash collateral in long-duration assets in an attempt to reach for yield.

Indeed, the performance of the above extreme examples during the crisis is telling. As such, shadow banks with reasonable degrees of leverage and a diverse set of funding options generally survived the crisis, while those with excessive leverage and a relatively narrow set of funding options did not. There were exceptions, however, with some poorly run shadow banks surviving due to direct or indirect support from their FHC and DBD parents, and some well-run, specialist shadow banks, due to an asymmetric access to last resort funding due to the lack of a bank parent with discount window access, being forced into liquidation by lender-of-last resort repo counterparties.

I.6 BACKSTOPPING THE SHADOW BANKING SYSTEM

A special feature of wholesale funding markets—and hence the funding of shadow banking system—is that it intermediates predominantly institutional cash balances, such as those of corporations, institutional investors and municipalities. In contrast, the traditional banking system is more reliant on retail cash balances for funding (in the form of retail deposits).³⁰

³⁰ While retail money market mutual funds manage retail funds, the MMMF manager (an institutional money manager (or money market intermediary)) acts as an institutional fiduciary of the retail cash investors. As such, runs by retail money funds on certain funding instruments (ABCP or repo, for example) can be started MMMF managers, without retail investors actually pulling their cash under management by the fund. In this sense, runs on the shadow banking system are “intermediated”—they are started in the “spirit” of protecting end investors, and hence, runs are started on behalf of them.

The concentration of institutional cash balances in wholesale funding markets is important to highlight, since, as the crisis has shown, institutional cash balances are well-informed, herd-like and fickle, and as such, any entity, vehicle or activity that relies on them for funding and lacks contagion-free, alternative sources of liquidity, is an inherently fragile structure. The lack of an explicit, FDIC-like insurance for institutional cash pools is a key reason behind the instability of wholesale funding markets. As the crisis has shown, private credit risk repositories and credit lines from money center banks (both of which provided enhancements to loan pools that would secure them AAA rating) were ineffective substitutes for deposit insurance, as the providers of these puts were themselves contaminated during the crisis and scrambled for liquidity (see Exhibit 27).

This inherent instability of wholesale funding, and the heightened sensitivity of institutional investors that provide wholesale funds highlights the dilemma of whether the liabilities of wholesale-funded entities and vehicles need to (1) be insured just like bank deposits are, and (2) have access to an official lender of last resort to make them less prone to runs (a public good which of course would be in return for greater regulatory oversight of the entities involved).

Interestingly, over a year after the liquidity crisis began in August 2007, at the height of the financial crisis in October 2008, official credit and liquidity puts were extended to the shadow banking system, and by extension, the institutional cash pools (or shadow bank “depositors”) that fund it.

Policy actions have been many and varied throughout the crisis. Initial actions, such as the failed M-LEC plan (September 2007) may have accelerated the crisis as it painted all ABCP-funded, levered ABS intermediaries with the same brush, ignoring the rich variety of the quality of their asset portfolios and the diversity of their funding strategies, effectively contributing to the wholesale run on the sector. Subsequent actions served to inject liquidity into the traditional banking system and also indirectly into the shadow banking system through commercial banks, and later to broker-

Exhibit 27: The Pre-Crisis Backstops of the Shadow Credit Intermediation Process - The Case of FHCs

Prior to the financial crisis, the credit intermediation process of the shadow banking system was privately enhanced. In this figure, we examine the enhancements to a typical FHC's credit intermediation process. Of the seven steps involved in the shadow credit intermediation process, only the first step (loan origination) is officially enhanced as it is conducted from a commercial bank. The commercial bank's activities are backstopped by credit and liquidity puts provided by the FDIC and the Federal Reserve through deposit insurance and discount window lending, respectively. The remaining six steps in an FHC's credit intermediation process were privately enhanced, however. Consortiums of commercial banks were providing liquidity puts through commercial credit lines to conduits and SIVs (loan and ABS warehouses, and ABS intermediaries, respectively) and the 16-party clearing banks (PMMoegaun Chase and B&NY) were providing private-credit to broker-dealers and daytime money funds of or through repos to MMATs that fund them. Private credit risk exposures were making risky assets safe by "wrapping" them with credit puts. The loans, ABS, and CDOs were wrapped by mortgage insurers, monoline insurers and AIG-1P, respectively, included in the system as credit-risk free assets that were used for collateral for funding via ABCP and repo. When the quality of these credit puts came into question, the value of collateral fell, ABCP could not pay the riskier, repo haircut rose and the private liquidity puts were triggered. To provide the funding that has been agreed to via the liquidity puts, the funding providers (commercial banks) had to tap the unsecured interbank market, where the flood of bids for funding went (Lombard spreads showed).

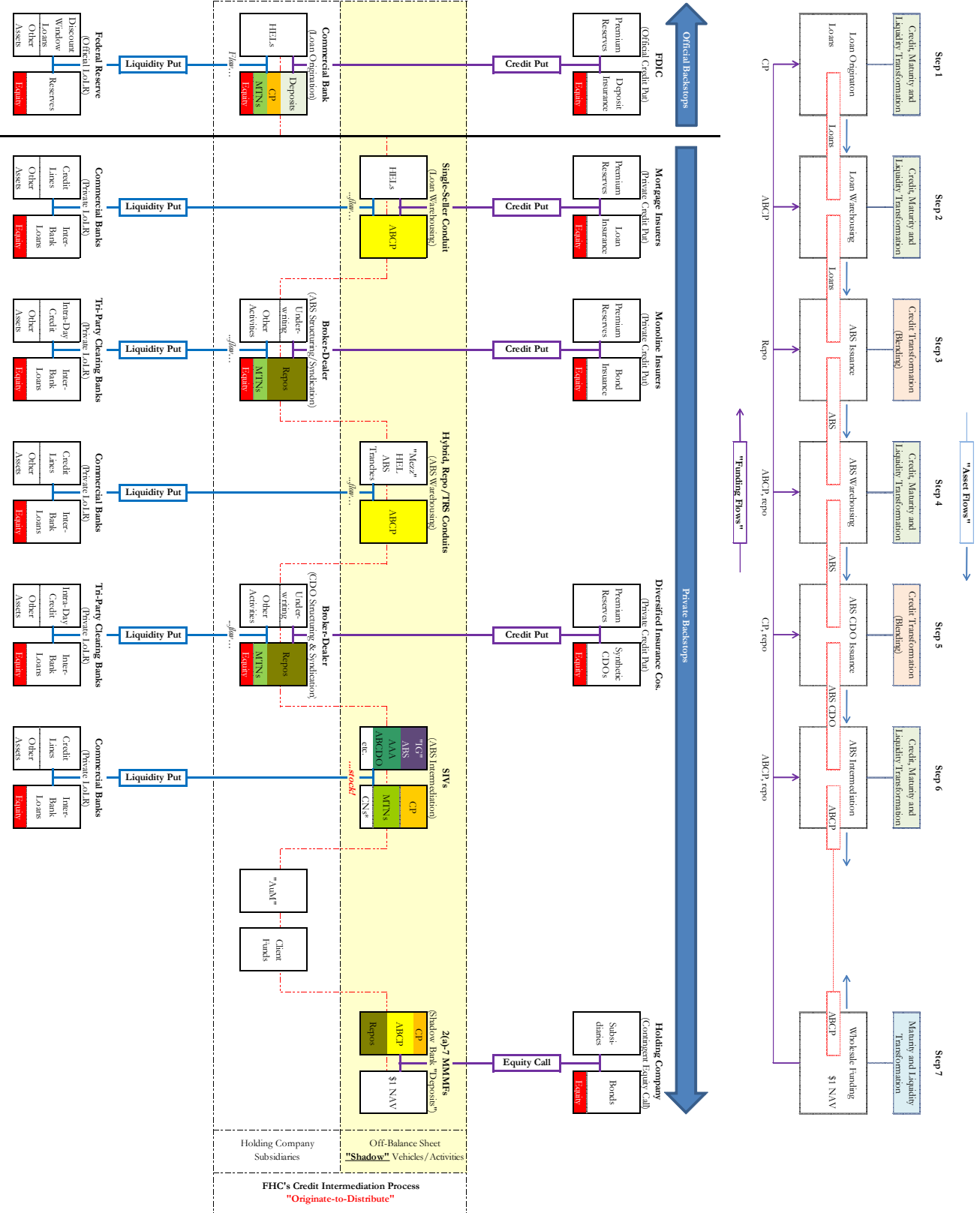

Source: Shadow Banking (Peters, Adrian, Ashcraft, Boesky (2010))

dealers. However, it was not until the breakdown of commercial banks' and broker dealers' ability and willingness to provide their lender of last resort and underwriter functions to shadow banks (especially to independent, stand-alone specialists) in the wake of Lehman's collapse that the Federal Reserve provided any direct support to the *broader*, non-bank and non-broker-dealer-affiliated parts of the shadow banking system.

Indeed, the Federal Reserve's 13(3) emergency lending facilities that followed in the wake of Lehman's bankruptcy amount to a 360° backstop of the functional steps involved in the shadow credit intermediation process. The facilities introduced during the crisis were an explicit recognition of the need to channel emergency funds into "internal", "external" and government-sponsored shadow banking sub-systems (see Exhibit 28).

As such, the Commercial Paper Funding Facility (CPFF) is a backstop of the CP and ABCP issuance of loan originators and loan warehouses, respectively (steps 1 and 2 of the shadow credit intermediation process); the Term Asset-Backed Loan Facility (TALF) is a backstop of ABS issuance (step 3); Maiden Lane LLC was a backstop of Bear Stearns' ABS warehouse, while the Term Securities Lending Facility (TSLF) was a means to improve the average quality of broker-dealers securities warehouses through swapping ABS for Treasuries (step 4); Maiden Lane III LLC was a backstop of AIG-Financial Products' credit puts on ABS CDOs (step 5); and the Term Auction Facility (TAF) and the FX swaps with foreign central banks were meant to facilitate the "onboarding" and on-balance sheet, dollar funding of the ABS portfolios of formerly off-balance sheet ABS intermediaries—mainly SIVs and securities arbitrage conduits (step 6).³¹

³¹ The TAF facility was only available to bank or FHC-affiliated ABS intermediaries. Standalone ABS intermediaries (LPFCs and independently managed SIVs and securities arbitrage conduits) and the ABS intermediaries of pension funds, insurance companies and monoline insurers did not benefit from "intermediated" access to the discount window.

Finally, the Primary Dealer Credit Facility (PDCF) was a backstop of the tri-party repo system through which MMMFs and other funds fund broker-dealers in wholesale funding markets overnight, and the AMLF and the Money Market Investor Funding Facility (MMIFF³) served as liquidity backstops of regulated and unregulated money market intermediaries, respectively (step 7).

Exhibit 29: FDIC Guaranteed Debt (TLGP) - A New Form of Deposit Insurance...

\$ millions

Company	Issuance of TLGP Debt			Total Issued	Maturity of TLGP Debt Issued				
	2008	2009	2010		2009	2010	2011	2012	2013
Bank Holding Companies									
Citigroup Inc	5,750	58,850	0	64,600	0	6,350	20,250	38,000	0
Bank of America Corp	19,850	21,850	0	41,700	0	14,250	3,600	23,850	0
JPMorgan Chase & Co	17,900	19,679	0	37,579	0	4,350	13,050	20,179	0
Wells Fargo & Co	6,000	3,500	0	9,500	0	0	6,000	3,500	0
State Street Corp	0	3,950	0	3,950	0	0	2,450	1,500	0
PNC Financial Services Group Inc	2,900	1,000	0	3,900	0	0	900	3,000	0
Regions Financial Corp	3,500	0	0	3,500	0	1,750	1,750	0	0
SunTrust Banks Inc	2,750	576	0	3,326	0	750	2,000	576	0
US Bancorp	0	2,680	0	2,680	0	0	0	2,680	0
HSBC USA Inc (TLGP)	2,675	0	0	2,675	0	0	2,675	0	0
Keycorp	1,500	438	0	1,938	0	250	250	1,438	0
Sovereign Bancorp (TLGP)	1,600	0	0	1,600	0	0	0	1,600	0
Union Bank	0	1,000	0	1,000	0	0	500	500	0
Bank of the West	0	1,000	0	1,000	0	0	0	1,000	0
Bank of New York Mellon Corp	0	603	0	603	0	0	0	603	0
New York Community Bancorp Inc	602	0	0	602	0	0	512	90	0
Huntington Bancshares Inc/OH	0	600	0	600	0	0	0	600	0
Zions Bancorporation	0	255	0	255	0	0	0	255	0
Total	65,027	115,981	0	181,008	0	27,700	53,937	99,371	0
Finance Companies									
General Electric Capital Corp	11,350	41,365	0	52,715	0	5,550	17,500	29,665	0
Deere & Co	2,000	0	0	2,000	0	0	0	2,000	0
Total	13,350	41,365	0	54,715	0	5,550	17,500	31,665	0
Bank Holding Companies (Former Broker-Dealers)									
Morgan Stanley	9,775	13,800	0	23,575	0	2,500	8,175	12,900	0
Goldman Sachs Group Inc.	7,025	10,600	0	17,625	0	1,725	7,400	8,500	0
Total	16,800	24,400	0	41,200	0	4,225	15,575	21,400	0
Bank Holding Companies (Former Finance Companies)									
GMAC LLC	0	7,400	0	7,400	0	0	0	7,400	0
American Express Co	5,900	0	0	5,900	0	750	5,150	0	0
Total	5,900	7,400	0	13,300	0	750	5,150	7,400	0
Thrift Holding Companies									
MetLife Inc	0	397	0	397	0	0	0	397	0
Total	0	397	0	397	0	0	0	397	0
Grand Total	87,727	148,178	0	235,905	0	32,675	74,662	128,568	0

Source: JPMorgan, authors

Similarly, the FDIC's Temporary Liquidity Guarantee Program that covered (1) various bank and non-bank financial institutions' senior unsecured debt, (2) corporations' non-interest bearing deposit transaction accounts, regardless of dollar amount, and (3) the U.S. Department of Treasury's temporary guarantee program of retail and institutional money market mutual funds were also backstops to the funding of the shadow banking system, and are all modern-day equivalents of deposit insurance (for the list and institutional form of TLGP debt issuers see Exhibit 29).

Finally, backstops of the government-sponsored shadow banking sub-system included the large-scale purchases of agency MBS and agency debt by the Federal Reserve, with these purchases effectively amounting to the funding of the activities of Fannie Mae, Freddie Mac and the FHLBs. Backstopping the government-sponsored shadow banking sub-system did not require building facilities, since as OMO-eligible collateral, the Federal Reserve could purchase agency MBS and agency securities outright.³²

Upon the full rollout of the liquidity facilities, large-scale asset purchases and guarantee schemes, the shadow banking system was fully embraced by official credit and liquidity puts, and became fully backstopped, just like the traditional banking system. As a result, the run on it was fully checked.

³² The large-scale asset purchases (LSAPs) of Agency debt and MBS were expansions, not de novo creations of support.

I.7 CONCLUSIONS

Following our analysis of the shadow banking system, we provide a 9-point summary of our conclusions and the challenges posed by the omnipresence of shadow banking in advanced financial systems.

(1) The volume of credit intermediated by the shadow banking system is just as large as the volume of credit intermediated by the traditional banking system:

At the eve of the financial crisis, the volume of credit intermediated by the shadow banking system was close to \$20 trillion, or nearly twice as large as the volume of credit intermediated by the traditional banking system at roughly \$11 trillion. Today, the comparable figures are \$16 and \$13 trillion, respectively.

We have defined shadow credit intermediation to include three broad types of activities differentiated by their strength of official enhancement: implicitly-enhanced, indirectly-enhanced, and unenhanced. The first category largely refers to intermediation by the GSEs, which issue debt implicitly guaranteed by the U.S. taxpayer. The second category largely refers to the off-balance sheet credit intermediation activities of institutions with explicit or implicit puts to the official sector, and includes the conduit, SIV, credit derivative and asset management activities of banks; the MBS guarantees of the GSEs; and the clearing of tri-party repo, to name the largest ones. Unenhanced liabilities refer to credit intermediation activities which take place without any implicit or indirect official enhancement, and include financial guarantees; the liabilities issued by non-bank finance companies, limited purpose finance companies (LPFCs) and stand-alone SIVs; and the \$1 NAV shares of both regulated and unregulated stand-alone money market intermediaries.

(2) The shadow banking system has three sub-systems which intermediate different types of credit, in fundamentally different ways:

The government-sponsored shadow banking sub-system refers to credit intermediation activities funded through the sale of Agency debt and MBS, which mainly includes conforming residential and commercial mortgages. These loans are originated and serviced by banks and non-bank finance companies. Through its investment portfolios of non-Agency MBS, CMBS and other ABS, this system also provided funding for a broad range of credit to households and businesses. This sub-system intermediates credit through the originate-to-distribute model of securitization.

The “internal” shadow banking sub-system refers to the credit intermediation process of a global network of banks, finance companies, broker-dealers and asset managers and their on- and off-balance sheet activities—all under the umbrella of financial holding companies. This sub-system intermediates mainly credit card loans, student loans, non-conforming residential mortgages, commercial mortgages and leveraged loans. Other than credit card securitizations, this sub-system also operated through the originate-to-distribute model of securitization.

Finally, the “external” shadow banking sub-system refers to the credit intermediation process of diversified broker-dealers (DBDs), and a global network of independent, non-bank financial specialists that include captive and standalone finance companies, limited purpose finance companies and asset managers. The DBDs of this sub-system originated residential and commercial real estate loans, as well as leveraged loans, while the independent specialists-based credit intermediation network originated auto loans and leases, equipment leases, student loans, aircraft and fleet loans and leases, dealer floorplan loans, middle-market loans and franchise loans. Unlike the GSE, FHC and DBD-based credit intermediation processes, the intermediation process of independent specialists operated through the originate-to-fund model of securitization.

(3) Some segments of the shadow banking system have emerged through various channels of arbitrage with limited economic value...:

Many “internal” and “external” shadow banks existed in a form that was possible only due to special circumstances in the run up to the financial crisis—some of these circumstances were economic in nature, and some were due to regulatory and risk management failures. Consequently these shadow banks are unlikely to return—at least in their past form.

Given the conservatorship and recent de-listing of Fannie Mae and Freddie Mac, it is evident that the government-sponsored shadow banking sub-system had an inadequate amount of capital for the amount of risk it was taking. Furthermore, the presence of implicit credit puts to the U.S. taxpayer also likely weakened the discipline markets exerted on the GSEs with respect to their risk-taking. While it is difficult to anticipate the future state of these institutions, it will almost certainly involve smaller balance sheets, significantly greater amounts of capital and hence lower degrees of leverage.

Along the same lines, recent actions taken by bank regulators globally targeting re-securitization exposures, securitization exposures in trading books, and back-up lines of credit suggest that there were deficiencies in the rules governing the “internal” shadow banking sub-system. These regulatory actions are complemented by changes in rating agency criteria as well as investor sentiment regarding structured credits. Only time will tell if any of the “internal” shadow banks have an economic rationale to exist if FHCs are forced to hold adequate amounts of capital against their risk.

Finally, both non-bank regulators and rating agencies have advanced their views on the risks inherent in some structured credit activities in the “external” shadow banking sub-system. For example, the New York State Insurance Commissioner recently increased the costs for monolines to wrap tranches of ABS CDOs through Operating Circular 19. Moreover, recent changes in rating criteria by the rating agencies suggest that AAA credit enhancement levels for new transactions

would be very high without diversification across vintage, country, and sector. Consequently, it seems unlikely that ABS CDOs will rise from the dead at any point in the near future.

(4) ...but, equally large segments of it have been driven by gains from specialization. It is more appropriate to refer to these segments as the “parallel” banking system:

Shadow banks are often more efficient than traditional banks through achieving economies of scale in the origination, servicing, structuring, trading and funding of loans to both bankable and non-bankable credits. There is always scope for gains from specialization, and going forward, tougher capital and liquidity requirements on banks have the potential to make non-bank financial specialists even more prominent and competitive. Most (but not all) of the candidates for these roles can be found in the “external” shadow banking sub-system.

For example, non-bank finance companies have traditionally served subprime credit card or auto loan customers, or low-rated corporate credits like commercial airlines, which are not served by depository institutions. Moreover, it seems possible that the core historical business of the monoline insurers—municipal bond insurance—returns in one form or another, especially given the dire condition of state and municipal finances. Furthermore, given large, unfunded pension commitments in the system, insurers will continue to have incentives to reach for yield by investing in low-credit risk, AAA assets through some form of levered ABS intermediaries (such as LPFCs).

We prefer to label the “long-term viable” set of shadow banks that were driven not regulatory arbitrage, but by gains from specialization and comparative advantage over traditional banks as the “parallel” banking system.

(5) The collapse of the shadow banking system is not unprecedented in the context of the bank runs of the 19th century: ...

The collapse of the shadow banking system during the global financial crisis of 2007-09 has many parallels to the bank runs of the 19th century. For one, we can argue that today's traditional banking system used to be an inherently fragile "shadow banking" system until its activities became enhanced with official liquidity and credit puts by the Federal Reserve and FDIC, respectively. Before the creation of these public backstops, bank runs were frequent. The key contributing factors to these crises were the maturity and liquidity mismatch on bank balance sheets—while assets are long term, illiquid loans, liabilities are primarily liquid, short-term demand deposits. When depositors fear trouble and anticipate that other depositors *might* withdraw funding, it is rational for all to withdraw—a bank run ensues, followed by the eventual collapse of the bank. The thrust of our paper has been that the shadow banking system, taken in its entirety, conducts liquidity and maturity transformation functions identical to those conducted by traditional banks. During the crisis of 2007-2009, there were several episodes with striking similarities to the 19th century bank runs, including the week prior to Bear Stearns' collapse, and the month following the Lehman bankruptcy.

In modern bank runs (shadow bank runs)—as well as the classic bank runs—the behavior of wholesale funding providers through the withdrawal of funding might be rational from their point of view, but can be detrimental to the system and credit availability in the aggregate. As a result of such externalities inherent in runs, a deep question is whether the economically viable parts of the shadow banking system (that is, the "parallel" banking system) will ever be stable through credit cycles in the absence of official credit and liquidity puts. A related question is the economically viable scale of these shadow banks with lower levels of maturity and credit transformation.

(6) ...private sector balance sheets will always fail at internalizing systemic risk. The official sector will always have to step in to help:

Systemic risk is an externality arising from the activities of individual financial institutions. Even if each institution of the shadow banking system manages credit, market, and liquidity risk prudently, the system as a whole can be excessively vulnerable to shocks. For example, for all types of shadow banks that fall under the same functional step along the shadow credit intermediation process, forced deleveraging by a “badly-run” shadow bank will impact the pricing of all assets in the market place, which moves prices for all other institutions, many of which will be “well-run” shadow banks. In turn, the collapse of the balance sheet capacity of one institution thus impacts the balance sheet capacity of similar institutions (performing the same functional step) through the revaluation of asset prices. Balance sheet shrinkage to perform certain functions of the shadow credit intermediation process might in turn clog the arteries of the shadow banking system, impede the asset flows in it, and, by extension, the flow of credit to households and businesses.

Along the chain of specialist intermediaries in the shadow banking system, the weakest link in the chain is the pinch-point that can destabilize the entire chain. Over the course of the financial crisis, the main pinch-points were the providers of wholesale funding (money market investors, such as money market mutual funds, for example), which withdrew funding at the end of the chain and led to funding problems further up the chain, all the way to the ultimate borrowers.

The weak-link nature of wholesale funding providers is not surprising when little capital is held against their asset portfolios and investors have zero tolerance for credit losses. An interesting case in point are the chain of events that were sparked by the BNP funds (wholesale funding providers) that halted redemptions in the fall of 2007 due to their inability to price their subprime exposures, which then sparked refusals by other wholesale funding providers to roll the liabilities of ABS

intermediaries (LPFCs, SIVs, securities arbitrage conduits and credit hedge funds), which forced them to deleverage.

Tail risk insurance for both credit and liquidity risk will generally be underpriced. In systemic crises, correlations among assets and institutions increase sharply and converge to one. In other words, large quantities of liquidity and credit puts provided by the private sector are ineffective during times of systemic stress, as the put providers are least likely to perform on them when they are most needed. Examples of inadequately priced credit puts can be found in the insurance sector, while inadequately priced liquidity puts were primarily written by banks. Once liquidity dries up, all institutions are adversely affected. However, tail risk insurance is never adequately priced *ex ante*.

(7) The shadow banking system was temporarily brought into the “daylight” of public liquidity and liability insurance, but was then pushed back into the shadows:

The sum total of the emergency liquidity facilities, lending programs and large-scale asset purchases by the Federal Reserve, and the guarantee schemes of the FDIC and U.S. Treasury during the financial crisis provided a near-complete backstop of the shadow banking system. This backstop meant that the shadow banking system temporarily stepped out of the shadows, into the “sunlight” of the officially enhanced part of the financial system, just as the traditional banking system. Upon the expiry of these facilities, however, the system reverted back into the shadows once again, operating without explicit official enhancements. Given that securitized credit intermediation is reliant on both banks and shadow banks, the set of entities that have access to lender of last resort funding should be rethought.

(8) Through innovation and arbitrage shadow banks are omnipresent in advanced financial systems:

Regulatory arbitrage was the root motivation for many shadow banks to exist. Shadow banks created for the purposes of regulatory arbitrage will always exist—for every regulatory action (especially globally uncoordinated ones), there will almost certainly be an arbitrage reaction in the shadows.

That said, there were numerous shadow banks that were less the products of arbitrage and more the products of gains from specialization and competitive advantage over banks—these include finance companies, limited purpose finance companies (LPFCs) and money market funds, for example.

Time and again, history shows that activities regulated out of banks, or financial innovations conducted and embodied by non-bank financial specialists (such as money market mutual funds or finance companies) that pose a threat to the profitability of essential bank functions, are later acquired by banks—what’s “regulated and innovated out” is usually “acquired back in”.

(9) Regulation by function is a more potent style of regulation than regulation by institutional form. Regulation by function could have “caught” shadow banks earlier:

Regulation and innovation will to some degree always force and lure, respectively, the three bank activities of credit, maturity and liquidity transformation out of banks. Regulation by form alone, that is regulating *banks*, will almost always be arbitrated away by banks via shadow banks.

Banks and shadow banks perform the same function, however, which will never change. Credit intermediation by banks, and past, present and future forms of shadow banks will *always* involve credit, maturity and liquidity transformation—the classic functions through which returns on credit intermediation are earned. Regulating these “timeless” functions of credit intermediation is a more potent, harder to arbitrage form of regulation than regulation by institutional form.

REFERENCES

- Acharya, Viral, and Philipp Schnabl (2010): "Securitization without Risk Transfer," unpublished paper, New York University.
- Adrian, Tobias, Chris Burke, and Jamie McAndrews (2009): "The Federal Reserve's Primary Dealer Credit Facility," *Federal Reserve Bank New York Current Issues Economics and Finance* 15(4).
- Adrian, Tobias, Dina Marchioni and Karin Kimbrough (2009): "The Federal Reserve's Commercial Paper Funding Facility," *Federal Reserve Bank of New York Economic Policy Review*, forthcoming.
- Adrian, Tobias and Hyun Song Shin (2009): "The Shadow Banking System: Implications for Financial Regulation," *Banque de France Financial Stability Review* 13, pp. 1-10.
- Adrian, Tobias and Hyun Song Shin (2009): "Money, Liquidity and Monetary Policy," *American Economic Review* 99(2).
- Adrian, Tobias and Hyun Song Shin (2010): "The Changing Nature of Financial Intermediation and the Financial Crisis of 2007–2009," *Annual Review of Economics*, forthcoming.
- Aitken, James and Manmohan Singh (2009): "Deleveraging after Lehman—Evidence from Reduced Rehyothecation," *IMF Working Paper* 09/42.
- Armantier Olivier, Sandy Krieger and Jamie McAndrews (2008): "The Federal Reserve's Term Auction Facility," *Federal Reserve Bank of New York Current Issues in Economics and Finance* 14(5).
- Ashcraft, Adam B. (2005): "Are Banks Really Special? New Evidence from the FDIC-Induced Failure of Healthy Banks," *American Economic Review* 95(5).
- Ashcraft, Adam B., and Til Schuermann (2007): "Understanding the Securitization of Subprime Mortgage Credit," *Foundations and Trends in Finance* 2(3).
- Ashcraft, Adam, Allan Malz, and Zoltan Pozsar (2010): "The Federal Reserve's Term Asset-Backed Securities Loan Facility," *Federal Reserve Bank of New York Economic Policy Review*, forthcoming.
- Bernanke, Ben S. (1983): "Nonmonetary Effects of the Financial Crisis in the Propagation of the Great Depression," *American Economic Review* 73(3).
- Bernanke, Ben S. (2005): "The Global Saving Glut and the U.S. Current Account Deficit," *At the Sandridge Lecture, Virginia Association of Economics, Richmond, Virginia*
- Brunnermeier, Markus (2009): "De-ciphering the credit crisis of 2007," *Journal Economic Perspectives* 23(1): pp. 77–100.
- Brunnermeier, Markus, Crockett, Andrew, Goodhart Charles, Persaud Avinash, Shin Hyun Song (2009): "The Fundamental Principles of Financial Regulation," *Geneva Report World Economy* 11.
- Corrigan, E. Gerald (2000): "Are Banks Special?—A Revisitation" *The Region, Banking and Policy Issues Magazine, March 2000, the Federal Reserve Bank of Minneapolis*

Covitz, Daniel, Nellie Liang, and Gustavo Suarez (2009): "The Evolution of a Financial Crisis: Panic in the Asset-Backed Commercial Paper Market," *Board of Governors of the Federal Reserve System Finance and Economics Discussion Series* 2009-36.

Coval, Joshua, Jakub Jurek, and Erik Stafford (2007): "Economic Catastrophe Bonds" *American Economic Review* 99(3).

Eichner, Matthew, J., Donald L. Kohn and Michael G. Palumbo (2010): "Financial Statistics for the United States and the Crisis: What Did They Get Right, What Did They Miss, and How Should They Change?" *Finance and Economics Discussion Series* 2010-20.

Fleming, Michael, Warren Hrunig, Frank Keane (2009): "The Term Securities Lending Facility: Origin, Design, and Effects," *Federal Reserve Bank of New York Current Issues of Economics and Finance* 15(2).

Frame, Scott and Lawrence White (2005): "Fussing and Fuming over Fannie and Freddie: How Much Smoke, How Much Fire?" *Journal of Economic Perspectives*, 19(2) pp. 159—184.

Geanakoplos, John (2010): "The Leverage Cycle," in *NBER Macroeconomics Annual* 2009, ed. Daron Acemoglu, Kenneth Rogoff, Michael Woodford. Chicago: Univ. Chicago Press.

Gorton, Gary (2009): "Slapped in the Face by the Invisible Hand: Banking and the Panic of 2007" *Federal Reserve Bank of Atlanta Jekyll Island Conference Proceedings*.

Király, Júlia, Nagy Márton and Szabó E. Viktor (2008): "Egy különleges eseménysorozat elemzése— a másodrendű jelzáloghitel-piaci válság és (hazai) következményei," *Közgazdasági Szemle, LV. Évf., 2008. július-augusztus* (573-621. o.).

Merton, Robert C. (1977): "An Analytical Derivation of the Cost of Deposit Insurance and Loan Guarantees," *Journal of Banking and Finance* 1, pp. 3-11.

Merton, Robert C. and Zvi Bodie (1993): "Deposit Insurance Reform: A Functional Approach," *Carnegie-Rochester Conference Series on Public Policy*, 38 (1993) 1-34.

McCulley, Paul (2007): "Teton Reflections," *PIMCO Global Central Bank Focus*

Pozsar, Zoltan (2008): "The Rise and Fall of the Shadow Banking System," *Moody's Economy.com*.

Rajan, Raghuram G. (2005): "Has Financial Development Made the World Riskier?" *NBER Working Paper No. W11728*

Wachter, Susan, Andrey Pavlov and Zoltan Pozsar (2008): "Subprime Lending and Real Estate Markets," in *Mortgage and Real Estate Finance*, edited by Stefania Perrucci, Risk Books.